



**SISTEM**  
**DO BRASIL** Ltda.



Componentes para Automação Pneumática

Linha **SM**



**CONEXÕES**  
FITTINGS

**VÁLVULAS DE FECHAMENTO**  
TAPS



**REGULADORES DE VELOCIDADE**  
FLOW REGULATORS



**2008:** nasce na província de Ningbo (RPC) a **SISTEM CHINA CO. LTD.**, uma sociedade resultado da joint venture entre a SISTEM PNEUMÁTICA, cuja qualidade é reconhecida há muito tempo no mercado europeu, e um parceiro chinês de produção, já presente no mercado asiático com clientela no mundo inteiro e portanto colaborador estratégico.

A **SISTEM CHINA CO. LTD** se estabelece no mercado com o objetivo de produzir uma linha de produtos para automação pneumática, para dar uma resposta, cada vez mais rápida, às demandas de seus clientes, em relação as suas necessidades e às exigências de mercado.

A contribuição da SISTEM PNEUMÁTICA na parceria é fundada na sua experiência, de mais de trinta anos, em realizar e projetar componentes para automação pneumática. Mediante a revisão técnica de detalhes existentes e projetando novas componentes, o padrão de qualidade da produção da **SISTEM CHINA CO. LTD** equipara-se aos parâmetros da SISTEM PNEUMÁTICA.



A proximidade com SHANGAI situa a SISTEM CHINA CO. LTD no centro daquele que é considerado, cada vez mais, o centro produtivo e econômico do cenário mundial.



CHO resultado dessa união técnico-produtiva é a SERIE K, uma linha completa de conexões, reguladoras e registros nos quais, graças à própria experiência, SISTEM PNEUMÁTICA quis inserir sua rosca cilíndrica com O Ring do tipo EASY, para garantir a máxima vedação em qualquer aplicação.



Linha **SIM**

## ISO9001:2008



ISO 9001

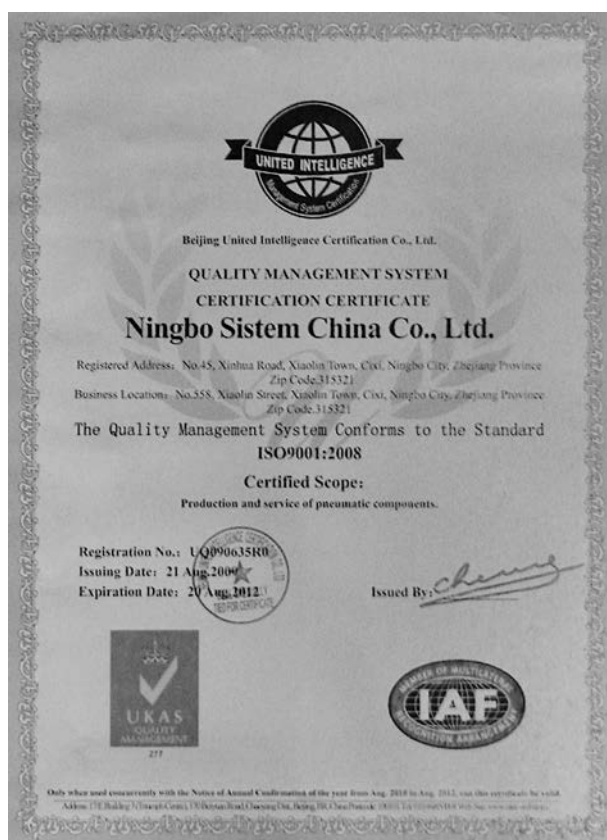



# CONEXÕES INSTANTÂNEAS PUSH-IN FITTINGS



**TUBO - Tube:**  
Ø4÷Ø14 - Ø5/32"÷Ø5/16"

**TIPOS DE TUBO RECOMENDADOS**  
TYPE OF RECOMMENDED TUBE



POLIURETANO  
POLIAMIDA ( RILSAN PA11/12)  
POLIETILENO  
POLIESTER  
TEFLON  
NYLON ( PA6 )

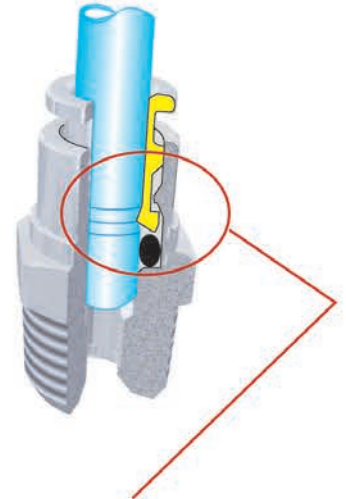

**TIPO DE ROSCA - Thread - Filet - Gewinde: M5÷M12 - 1/8"÷1/2"**  
cônica com Teflon, cônica NPT, cilíndrico e métrico com o-ring, fêmea  
tapered with Teflon, tapered NPT, parallel and metric with o-ring, female

**Sistema de ACOPLAMENTO / DESACOPLAMENTO DO TUBO**  
type of TUBE COUPLING

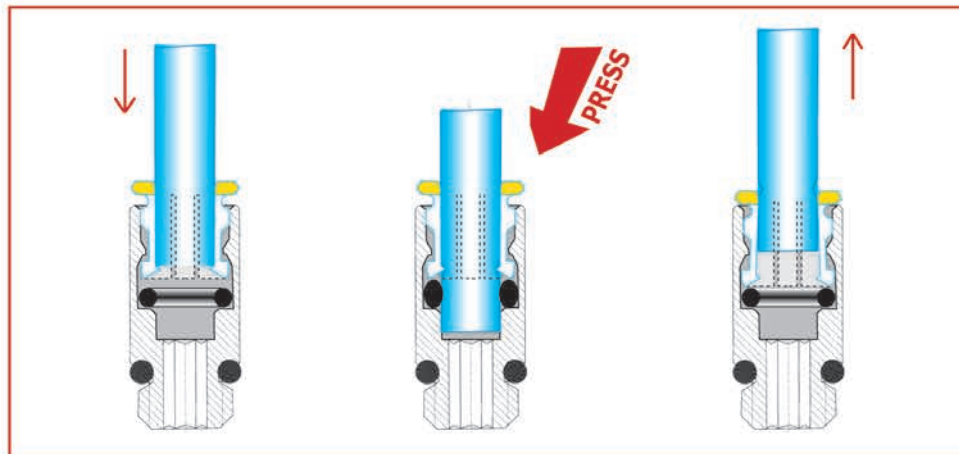

**O-RING/VEDAÇÕES**  **SEM SILICONE** **O-RING ESPECIAIS A PEDIDO**  
OIL-PROOF RUBBER SILICONE FREE SPECIAL O-RINGS ON REQUEST

### CARACTERÍSTICAS TÉCNICAS

LATÃO (EN12164-CW614N) NIQUELADO  
ZAMA 15 (UNI 3717) NIQUELADA  
O-RING EM BORRACHA ANTI-ÓLEO NBR  
PRESSÃO MÁXIMA DE TRABALHO : 16 BAR (1,6 MPa)  
TEMPERATURA DE TRABALHO: -10°C(263°K), +80°C (353°K)

### TECHNICAL FEATURES

NICKEL-PLATED BRASS (EN 12164-CW614N)  
NICKEL-PLATED ZAMA-15 (UNI 3717)  
OIL-PROOF RUBBER PACKINGS NBR  
MAX WORKING PRESSURE: 16 BAR (1,6 MPa)  
WORKING TEMPERATURE: -10°C (263°K), +80°C (353°K)







[ 2110 ] - [ Conexões Metálicas "SM" ]

[ 121 ]



Cód.	Rosca	Tubo Ø
[Conex. Reta Fixa c/ Rosca BSPT - Teflon]		
SM108040T	1/8	4
SM104040T	1/4	4
SM108050T	1/8	5
SM104050T	1/4	5
SM108060T	1/8	6
SM104060T	1/4	6
SM103060T	3/8	6
SM108080T	1/8	8
SM104080T	1/4	8
SM103080T	3/8	8
SM102080T	1/2	8
SM108100T	1/8	10
SM104100T	1/4	10
SM103100T	3/8	10
SM102100T	1/2	10
SM104120T	1/4	12
SM103120T	3/8	12
SM102120T	1/2	12
SM103140T	3/8	14
SM102140T	1/2	14
SM103160T	3/8	16
SM102160T	1/2	16

[ 122 ]

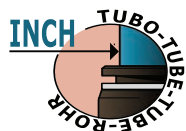

Cód.	Rosca	Tubo Ø
[Conex. Reta Fixa c/ Rosca BSPT - Teflon - Tubo INCH]		
SM108310T	1/8	3,18(1/8")
SM104310T	1/4	3,18(1/8")
SM108390T	1/8	3,97 (5/32")
SM104390T	1/4	3,97 (5/32")
SM108470T	1/8	4,76 (3/16")
SM104470T	1/4	4,76 (3/16")
SM103470T	3/8	4,76 (3/16")
SM108630T	1/8	6,35(1/4")
SM104630T	1/4	6,35(1/4")
SM103630T	3/8	6,35(1/4")
SM108790T	1/8	7,93(5/16")
SM104790T	1/4	7,93(5/16")
SM103790T	3/8	7,93(5/16")
SM102790T	1/2	7,93(5/16")
SM108950T	1/8	9,52(3/8")
SM104950T	1/4	9,52(3/8")
SM103950T	3/8	9,52(3/8")
SM102950T	1/2	9,52(3/8")
SM104270T	1/4	12,7(1/2")
SM103270T	3/8	12,7(1/2")
SM102270T	1/2	12,7(1/2")

[ 123 ]

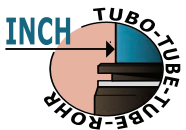

Cód.	Rosca	Tubo Ø
[Conex. Reta Fixa c/ Rosca NPT - Tubo INCH]		
SM10U310	10-32UNF	3,18(1/8")
SM10K310	1/8	3,18(1/8")
SM10X310	1/4	3,18(1/8")
SM10U390	10-32UNF	3,97 (5/32")
SM10K390	1/8	3,97 (5/32")
SM10X390	1/4	3,97 (5/32")
SM10U470	10-32UNF	4,76 (3/16")
SM10K470	1/8	4,76 (3/16")
SM10X470	1/4	4,76 (3/16")
SM10Y470	3/8	4,76 (3/16")
SM10U630	10-32UNF	6,35(1/4")
SM10K630	1/8	6,35(1/4")
SM10X630	1/4	6,35(1/4")
SM10Y630	3/8	6,35(1/4")
SM10K790	1/8	7,93(5/16")
SM10X790	1/4	7,93(5/16")
SM10Y790	3/8	7,93(5/16")
SM10Z790	1/2	7,93(5/16")
SM10K950	1/8	9,52(3/8")
SM10X950	1/4	9,52(3/8")
SM10Y950	3/8	9,52(3/8")
SM10Z950	1/2	9,52(3/8")
SM10X270	1/4	12,7(1/2")
SM10Y270	3/8	12,7(1/2")
SM10Z270	1/2	12,7(1/2")

[ 120 ]



Cód.	Rosca	Tubo Ø
[Conex. Reta c/ Rosca BSP + Oring]		
SM100338	M3	3
SM105038	M5	3
SM108038	1/8	3
SM105048	M5	4
SM108048	1/8	4
SM104048	1/4	4
SM105058	M5	5
SM108058	1/8	5
SM104058	1/4	5
SM105068	M5	6
SM108068	1/8	6
SM104068	1/4	6
SM108088	1/8	8
SM104088	1/4	8
SM103088	3/8	8
SM102088	1/2	8
SM108108	1/8	10
SM104108	1/4	10
SM103108	3/8	10
SM102108	1/2	10
SM108128	1/8	12
SM104128	1/4	12
SM103128	3/8	12
SM102128	1/2	12
SM103148	3/8	14
SM102148	1/2	14
SM103168	3/8	16
SM102168	1/2	16

[ 124 ]



Cód.	Rosca	Tubo Ø
[Conex. Reta REDUZIDA c/ Rosca BSPT - Teflon]		
SM10T8040T	1/8	4
SM10T4040T	1/4	4
SM10T8050T	1/8	5
SM10T4050T	1/4	5
SM10T8060T	1/8	6
SM10T4060T	1/4	6
SM10T8080T	1/8	8
SM10T4080T	1/4	8
SM10T3080T	3/8	8
SM10T2080T	1/2	8
SM10T8100T	1/8	10
SM10T4100T	1/4	10
SM10T3100T	3/8	10
SM10T2100T	1/2	10
SM10T4120T	1/4	12
SM10T3120T	3/8	12
SM10T2120T	1/2	12
SM10T3140T	3/8	14
SM10T2140T	1/2	14
SM10T3160T	3/8	16
SM10T2160T	1/2	16

[ 125 ]

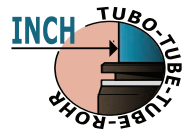

Cód.	Rosca	Tubo Ø
[Conex. Reta REDUZIDA c/ Rosca BSPT-Teflon Tubo INCH]		
SM10T8310T	1/8	3,18(1/8")
SM10T4310T	1/4	3,18 (1/8")
SM10T8390T	1/8	3,97 (5/32")
SM10T4390T	1/4	3,97 (5/32")
SM10T8470T	1/8	4,76 (3/16")
SM10T4470T	1/4	4,76 (3/16")
SM10T3470T	3/8	4,76 (3/16")
SM10T8630T	1/8	6,35(1/4")
SM10T4630T	1/4	6,35(1/4")
SM10T3630T	3/8	6,35(1/4")
SM10T8790T	1/8	7,93(5/16")
SM10T4790T	1/4	7,93(5/16")
SM10T3790T	3/8	7,93(5/16")
SM10T2790T	1/2	7,93(5/16")
SM10T8950T	1/8	9,52(3/8")
SM10T4950T	1/4	9,52(3/8")
SM10T3950T	3/8	9,52(3/8")
SM10T2950T	1/2	9,52(3/8")
SM10T4270T	1/4	12,7(1/2")
SM10T3270T	3/8	12,7(1/2")
SM10T2270T	1/2	12,7(1/2")

[ 126 ]



Cód.	Rosca	Tubo Ø
[Conex. Reta REDUZIDA c/ Rosca NPT - Tubo INCH]		
SM10TU310	10-32UNF	3,18(1/8")
SM10TK310	1/8	3,18(1/8")
SM10TX310	1/4	3,18(1/8")
SM10TU390	10-32UNF	3,97 (5/32")
SM10TK390	1/8	3,97 (5/32")
SM10TX390	1/4	3,97 (5/32")
SM10TU470	10-32UNF	4,76 (3/16")
SM10TK470	1/8	4,76 (3/16")
SM10TX470	1/4	4,76 (3/16")
SM10TY470	3/8	4,76 (3/16")
SM10TU630	10-32UNF	6,35(1/4")
SM10TK630	1/8	6,35(1/4")
SM10TX630	1/4	6,35(1/4")
SM10TY630	3/8	6,35(1/4")
SM10TK790	1/8	7,93(5/16")
SM10TX790	1/4	7,93(5/16")
SM10TY790	3/8	7,93(5/16")
SM10TZ790	1/2	7,93(5/16")
SM10TK950	1/8	9,52(3/8")
SM10TX950	1/4	9,52(3/8")
SM10TY950	3/8	9,52(3/8")
SM10TZ950	1/2	9,52(3/8")
SM10TX270	1/4	12,7(1/2")
SM10TY270	3/8	12,7(1/2")
SM10TZ270	1/2	12,7(1/2")

[ 127 ]



Cód.	Rosca	Tubo Ø
[Conex. Reta REDUZIDA c/ Rosca BSP + Oring]		
SM10T0338	M3	3
SM10T5038	M5	3
SM10T8038	1/8	3
SM10T5048	M5	4
SM10T8048	1/8	4
SM10T4048	1/4	4
SM10T5058	M5	5
SM10T8058	1/8	5
SM10T4058	1/4	5
SM10T5068	M5	6
SM10T8068	1/8	6
SM10T4068	1/4	6
SM10T8088	1/8	8
SM10T4088	1/4	8
SM10T3088	3/8	8
SM10T2088	1/2	8
SM10T8108	1/8	10
SM10T4108	1/4	10
SM10T3108	3/8	10
SM10T2108	1/2	10
SM10T8128	1/8	12
SM10T4128	1/4	12
SM10T3128	3/8	12
SM10T2128	1/2	12
SM10T3148	3/8	14
SM10T2148	1/2	14
SM10T3168	3/8	16
SM10T2168	1/2	16



[ 118 ]



Cód.	Rosca	Tubo Ø
<b>[Conex. Reta c/ Rosca FÊMEA BSP]</b>		
SM235040	M5	4
SM238040	1/8	4
SM234040	1/4	4
SM238050	1/8	5
SM234050	1/4	5
SM235060	M5	6
SM238060	1/8	6
SM234060	1/4	6
SM238080	1/8	8
SM234080	1/4	8
SM233080	3/8	8
SM232080	1/2	8
SM238100	1/8	10
SM234100	1/4	10
SM233100	3/8	10
SM232100	1/2	10
SM238120	1/8	12
SM234120	1/4	12
SM233120	3/8	12
SM232120	1/2	12
SM233140	3/8	14
SM232140	1/2	14
SM233160	3/8	16
SM232160	1/2	16

[ 119 ]

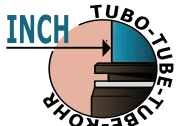

Cód.	Rosca	Tubo Ø
<b>[Conex. Reta c/ Rosca FÊMEA BSP - Tubo INCH]</b>		
SM238310	1/8	3,18(1/8")
SM234310	1/4	3,18 (1/8")
SM238390	1/8	3,97 (5/32")
SM234390	1/4	3,97 (5/32")
SM238470	1/8	4,76 (3/16")
SM234470	1/4	4,76 (3/16")
SM233470	3/8	4,76 (3/16")
SM238630	1/8	6,35(1/4")
SM234630	1/4	6,35(1/4")
SM233630	3/8	6,35(1/4")
SM238790	1/8	7,93(5/16")
SM234790	1/4	7,93(5/16")
SM233790	3/8	7,93(5/16")
SM232790	1/2	7,93(5/16")
SM238950	1/8	9,52(3/8")
SM234950	1/4	9,52(3/8")
SM233950	3/8	9,52(3/8")
SM232950	1/2	9,52(3/8")
SM234270	1/4	12,7(1/2")
SM233270	3/8	12,7(1/2")
SM232270	1/2	12,7(1/2")

[ 128 ]

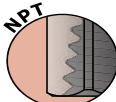
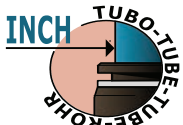

Cód.	Rosca	Tubo Ø
<b>[Conex. Reta c/ Rosca FÊMEA NPT - Tubo INCH]</b>		
SM23K310	1/8	3,18 (1/8")
SM23X310	1/4	3,18 (1/8")
SM23K390	1/8	3,97 (5/32")
SM23X390	1/4	3,97 (5/32")
SM23K470	1/8	4,76 (3/16")
SM23X470	1/4	4,76 (3/16")
SM23Y470	3/8	4,76 (3/16")
SM23K630	1/8	6,35(1/4")
SM23X630	1/4	6,35(1/4")
SM23Y630	3/8	6,35(1/4")
SM23U630	10-32UNF	6,35(1/4")
SM23K790	1/8	7,93(5/16")
SM23X790	1/4	7,93(5/16")
SM23Y790	3/8	7,93(5/16")
SM23Z790	1/2	7,93(5/16")
SM23K950	1/8	9,52 (3/8")
SM23X950	1/4	9,52(3/8")
SM23Y950	3/8	9,52(3/8")
SM23Z950	1/2	9,52 (3/8")
SM23X270	1/4	12,7(1/2")
SM23Y270	3/8	12,7(1/2")
SM23Z270	1/2	12,7 (1/2")

[ 209 ]



Cód.	Rosca	Tubo Ø
<b>[Conex. em "L" Giratório c/ Rosca BSPT - Teflon]</b>		
SM208040T	1/8	4
SM204040T	1/4	4
SM208050T	1/8	5
SM204050T	1/4	5
SM208060T	1/8	6
SM204060T	1/4	6
SM203060T	3/8	6
SM208080T	1/8	8
SM204080T	1/4	8
SM203080T	3/8	8
SM202080T	1/2	8
SM208100T	1/8	10
SM204100T	1/4	10
SM203100T	3/8	10
SM202100T	1/2	10
SM204120T	1/4	12
SM203120T	3/8	12
SM202120T	1/2	12
SM203140T	3/8	14
SM202140T	1/2	14
SM203160T	3/8	16
SM202160T	1/2	16

[ 211 ]



Cód.	Rosca	Tubo Ø
<b>[Conex. "L" Giratório c/Rosca BSPT-Teflon-Tubo INCH]</b>		
SM208310T	1/8	3,18(1/8")
SM204310T	1/4	3,18 (1/8")
SM208390T	1/8	3,97 (5/32")
SM204390T	1/4	3,97 (5/32")
SM208470T	1/8	4,76 (3/16")
SM204470T	1/4	4,76 (3/16")
SM203470T	3/8	4,76 (3/16")
SM208630T	1/8	6,35(1/4")
SM204630T	1/4	6,35(1/4")
SM203630T	3/8	6,35(1/4")
SM208790T	1/8	7,93(5/16")
SM204790T	1/4	7,93(5/16")
SM203790T	3/8	7,93(5/16")
SM202790T	1/2	7,93(5/16")
SM208950T	1/8	9,52(3/8")
SM204950T	1/4	9,52(3/8")
SM203950T	3/8	9,52(3/8")
SM202950T	1/2	9,52(3/8")
SM204270T	1/4	12,7(1/2")
SM203270T	3/8	12,7(1/2")
SM202270T	1/2	12,7(1/2")

[ 212 ]

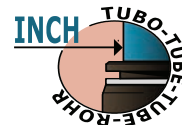

Cód.	Rosca	Tubo Ø
<b>[Conex. em "L" Giratório c/ Rosca NPT - Tubo INCH]</b>		
SM20U310	10-32UNF	3,18 (1/8")
SM20K310	1/8	3,18 (1/8")
SM20X310	1/4	3,18 (1/8")
SM20U390	10-32UNF	3,97 (5/32")
SM20K390	1/8	3,97 (5/32")
SM20X390	1/4	3,97 (5/32")
SM20U470	10-32UNF	4,76 (3/16")
SM20K470	1/8	4,76 (3/16")
SM20X470	1/4	4,76 (3/16")
SM20Y470	3/8	4,76 (3/16")
SM20U630	10-32UNF	6,35(1/4")
SM20K630	1/8	6,35(1/4")
SM20X630	1/4	6,35(1/4")
SM20Y630	3/8	6,35(1/4")
SM20K790	1/8	7,93(5/16")
SM20X790	1/4	7,93(5/16")
SM20Y790	3/8	7,93(5/16")
SM20Z790	1/2	7,93(5/16")
SM20K950	1/8	9,52(3/8")
SM20X950	1/4	9,52(3/8")
SM20Y950	3/8	9,52(3/8")
SM20Z950	1/2	9,52(3/8")
SM20X270	1/4	12,7(1/2")
SM20Y270	3/8	12,7(1/2")
SM20Z270	1/2	12,7(1/2")

[ 227 ]



Cód.	Rosca	Tubo Ø
<b>[Conex. em "L" Giratório c/ Rosca BSP + Oring]</b>		
SM200338	M3	3
SM205038	M5	3
SM208038	1/8	3
SM205048	M5	4
SM208048	1/8	4
SM204048	1/4	4
SM205058	M5	5
SM208058	1/8	5
SM204058	1/4	5
SM205068	M5	6
SM208068	1/8	6
SM204068	1/4	6
SM208088	1/8	8
SM204088	1/4	8
SM203088	3/8	8
SM202088	1/2	8
SM208108	1/8	10
SM204108	1/4	10
SM203108	3/8	10
SM202108	1/2	10
SM208128	1/8	12
SM204128	1/4	12
SM203128	3/8	12
SM202128	1/2	12
SM203148	3/8	14
SM202148	1/2	14
SM203168	3/8	16
SM202168	1/2	16



**[ 229 ]**



Cód.	Rosca	Tubo Ø
<b>[Conex. em "L" Fixo c/ Rosca BSPT - Teflon]</b>		
SM218040T	1/8	4
SM214040T	1/4	4
SM218050T	1/8	5
SM214050T	1/4	5
SM218060T	1/8	6
SM214060T	1/4	6
SM218080T	1/8	8
SM214080T	1/4	8
SM213080T	3/8	8
SM212080T	1/2	8
SM218100T	1/8	10
SM214100T	1/4	10
SM213100T	3/8	10
SM212100T	1/2	10
SM214120T	1/4	12
SM213120T	3/8	12
SM212120T	1/2	12
SM213140T	3/8	14
SM212140T	1/2	14
SM213160T	3/8	16
SM212160T	1/2	16

**[ 230 ]**

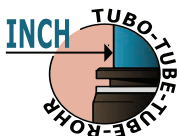

Cód.	Rosca	Tubo Ø
<b>[Conex. em "L" Fixo c/ Rosca BSPT-Teflon - Tubo INCH]</b>		
SM218310T	1/8	3,18(1/8")
SM214310T	1/4	3,18(1/8")
SM218390T	1/8	3,97(5/32")
SM214390T	1/4	3,97(5/32")
SM218470T	1/8	4,76(3/16")
SM214470T	1/4	4,76(3/16")
SM213470T	3/8	4,76(3/16")
SM218630T	1/8	6,35(1/4")
SM214630T	1/4	6,35(1/4")
SM213630T	3/8	6,35(1/4")
SM218790T	1/8	7,93(5/16")
SM214790T	1/4	7,93(5/16")
SM213790T	3/8	7,93(5/16")
SM212790T	1/2	7,93(5/16")
SM218950T	1/8	9,52(3/8")
SM214950T	1/4	9,52(3/8")
SM213950T	3/8	9,52(3/8")
SM212950T	1/2	9,52(3/8")
SM214270T	1/4	12,7(1/2")
SM213270T	3/8	12,7(1/2")
SM212270T	1/2	12,7(1/2")

**[ 231 ]**

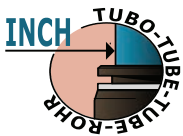

Cód.	Rosca	Tubo Ø
<b>[Conex. em "L" Fixo c/ Rosca NPT - Tubo INCH]</b>		
SM21U310	10-32UNF	3,18(1/8")
SM21K310	1/8	3,18(1/8")
SM21X310	1/4	3,18(1/8")
SM21U390	10-32UNF	3,97(5/32")
SM21K390	1/8	3,97(5/32")
SM21X390	1/4	3,97(5/32")
SM21U470	10-32UNF	4,76(3/16")
SM21K470	1/8	4,76(3/16")
SM21X470	1/4	4,76(3/16")
SM21Y470	3/8	4,76(3/16")
SM21U630	10-32UNF	6,35(1/4")
SM21K630	1/8	6,35(1/4")
SM21X630	1/4	6,35(1/4")
SM21Y630	3/8	6,35(1/4")
SM21K790	1/8	7,93(5/16")
SM21X790	1/4	7,93(5/16")
SM21Y790	3/8	7,93(5/16")
SM21Z790	1/2	7,93(5/16")
SM21K950	1/8	9,52(3/8")
SM21X950	1/4	9,52(3/8")
SM21Y950	3/8	9,52(3/8")
SM21Z950	1/2	9,52(3/8")
SM21X270	1/4	12,7(1/2")
SM21Y270	3/8	12,7(1/2")
SM21Z270	1/2	12,7(1/2")

**[ 232 ]**



Cód.	Rosca	Tubo Ø
<b>[Conex. em "L" Fixo c/Rosca BSP + O'ring]</b>		
SM210338	M3	3
SM215038	M5	3
SM215048	M5	4
SM215058	M5	5
SM215068	M5	6

**[ 233 ]**



Cód.	Rosca	Tubo Ø
<b>[Conex. em "L" Longo c/ Rosca BSPT - Teflon]</b>		
SM20L8040T	1/8	4
SM20L4040T	1/4	4
SM20L8050T	1/8	5
SM20L4050T	1/4	5
SM20L8060T	1/8	6
SM20L4060T	1/4	6
SM20L8080T	1/8	8
SM20L4080T	1/4	8
SM20L3080T	3/8	8
SM20L2080T	1/2	8
SM20L8100T	1/8	10
SM20L4100T	1/4	10
SM20L3100T	3/8	10
SM20L2100T	1/2	10
SM20L8120T	1/8	12
SM20L4120T	1/4	12
SM20L3120T	3/8	12
SM20L2120T	1/2	12
SM20L3140T	3/8	14
SM20L2140T	1/2	14
SM20L3160T	3/8	16
SM20L2160T	1/2	16

**[ 234 ]**

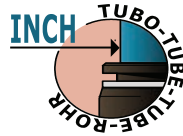

Cód.	Rosca	Tubo Ø
<b>[Conex. em "L" Longo c/ Rosca BSPT-Teflon-Tubo INCH]</b>		
SM20L8310T	1/8	3,18(1/8")
SM20L4310T	1/4	3,18(1/8")
SM20L8390T	1/8	3,97(5/32")
SM20L4390T	1/4	3,97(5/32")
SM20L8470T	1/8	4,76(3/16")
SM20L4470T	1/4	4,76(3/16")
SM20L3470T	3/8	4,76(3/16")
SM20L8630T	1/8	6,35(1/4")
SM20L4630T	1/4	6,35(1/4")
SM20L3630T	3/8	6,35(1/4")
SM20L8790T	1/8	7,93(5/16")
SM20L4790T	1/4	7,93(5/16")
SM20L3790T	3/8	7,93(5/16")
SM20L2790T	1/2	7,93(5/16")
SM20L8950T	1/8	9,52(3/8")
SM20L4950T	1/4	9,52(3/8")
SM20L3950T	3/8	9,52(3/8")
SM20L2950T	1/2	9,52(3/8")
SM20L4270T	1/4	12,7(1/2")
SM20L3270T	3/8	12,7(1/2")
SM20L2270T	1/2	12,7(1/2")

**[ 235 ]**

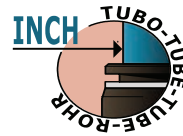

Cód.	Rosca	Tubo Ø
<b>[Conex. em "L" Longo c/ Rosca NPT - Tubo INCH]</b>		
SM20LU310	10-32UNF	3,18(1/8")
SM20LK310	1/8	3,18(1/8")
SM20LX310	1/4	3,18(1/8")
SM20LU390	10-32UNF	3,97(5/32")
SM20LK390	1/8	3,97(5/32")
SM20LX390	1/4	3,97(5/32")
SM20LU470	10-32UNF	4,76(3/16")
SM20LK470	1/8	4,76(3/16")
SM20LX470	1/4	4,76(3/16")
SM20LY470	3/8	4,76(3/16")
SM20LU630	10-32UNF	6,35(1/4")
SM20LK630	1/8	6,35(1/4")
SM20LX630	1/4	6,35(1/4")
SM20LY630	3/8	6,35(1/4")
SM20LK790	1/8	7,93(5/16")
SM20LX790	1/4	7,93(5/16")
SM20LY790	3/8	7,93(5/16")
SM20LZ790	1/2	7,93(5/16")
SM20LK950	1/8	9,52(3/8")
SM20LX950	1/4	9,52(3/8")
SM20LY950	3/8	9,52(3/8")
SM20LZ950	1/2	9,52(3/8")
SM20LX270	1/4	12,7(1/2")
SM20LY270	3/8	12,7(1/2")
SM20LZ270	1/2	12,7(1/2")





[ 236 ]



Cód.	Rosca	Tubo Ø
[Conex. em "L" Longo c/ Rosca BSP + Oring]		
SM20L5048	M5	4
SM20L8048	1/8	4
SM20L4048	1/4	4
SM20L5058	M5	5
SM20L8058	1/8	5
SM20L4058	1/4	5
SM20L5068	M5	6
SM20L8068	1/8	6
SM20L4068	1/4	6
SM20L8088	1/8	8
SM20L4088	1/4	8
SM20L3088	3/8	8
SM20L2088	1/2	8
SM20L8108	1/8	10
SM20L4108	1/4	10
SM20L3108	3/8	10
SM20L2108	1/2	10
SM20L8128	1/8	12
SM20L4128	1/4	12
SM20L3128	3/8	12
SM20L2128	1/2	12
SM20L3148	3/8	14
SM20L2148	1/2	14
SM20L3168	3/8	16
SM20L2168	1/2	16

[ 237 ]



Cód.	Rosca	Tubo Ø
[Conex. Orientável em "L" c/ Rosca BSPT - Teflon]		
SM388040T	1/8	4
SM384040T	1/4	4
SM388050T	1/8	5
SM384050T	1/4	5
SM388060T	1/8	6
SM384060T	1/4	6
SM388080T	1/8	8
SM384080T	1/4	8
SM383080T	3/8	8
SM382080T	1/2	8
SM388100T	1/8	10
SM384100T	1/4	10
SM383100T	3/8	10
SM382100T	1/2	10
SM388120T	1/8	12
SM384120T	1/4	12
SM383120T	3/8	12
SM382120T	1/2	12
SM383140T	3/8	14
SM382140T	1/2	14
SM383160T	3/8	16
SM382160T	1/2	16

[ 238 ]

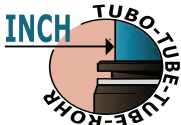

Cód.	Rosca	Tubo Ø
[Conex. Orientável em "L" c/ Rosca BSPT Teflon-Tubo INCH]		
SM388310T	1/8	3,18 (1/8")
SM384310T	1/4	3,18 (1/8")
SM388390T	1/8	3,97 (5/32")
SM384390T	1/4	3,97 (5/32")
SM388470T	1/8	4,76 (3/16")
SM384470T	1/4	4,76 (3/16")
SM383470T	3/8	4,76 (3/16")
SM388630T	1/8	6,35(1/4")
SM384630T	1/4	6,35(1/4")
SM383630T	3/8	6,35(1/4")
SM388790T	1/8	7,93(5/16")
SM384790T	1/4	7,93(5/16")
SM383790T	3/8	7,93(5/16")
SM382790T	1/2	7,93(5/16")
SM388950T	1/8	9,52(3/8")
SM384950T	1/4	9,52(3/8")
SM383950T	3/8	9,52(3/8")
SM382950T	1/2	9,52(3/8")
SM384270T	1/4	12,7(1/2")
SM383270T	3/8	12,7(1/2")
SM382270T	1/2	12,7(1/2")

[ 239 ]



Cód.	Rosca	Tubo Ø
[Conex. Orientável em "L" c/ Rosca NPT - Tubo INCH]		
SM38U310	10-32UNF	3,18(1/8")
SM38K310	1/8	3,18 (1/8")
SM38X310	1/4	3,18 (1/8")
SM38U390	10-32UNF	3,97 (5/32")
SM38K390	1/8	3,97 (5/32")
SM38X390	1/4	3,97 (5/32")
SM38U470	10-32UNF	4,76 (3/16")
SM38K470	1/8	4,76 (3/16")
SM38X470	1/4	4,76 (3/16")
SM38Y470	3/8	4,76 (3/16")
SM38U630	10-32UNF	6,35(1/4")
SM38K630	1/8	6,35(1/4")
SM38X630	1/4	6,35(1/4")
SM38Y630	3/8	6,35(1/4")
SM38K790	1/8	7,93(5/16")
SM38X790	1/4	7,93(5/16")
SM38Y790	3/8	7,93(5/16")
SM38Z790	1/2	7,93(5/16")
SM38K950	1/8	9,52(3/8")
SM38X950	1/4	9,52(3/8")
SM38Y950	3/8	9,52(3/8")
SM38Z950	1/2	9,52(3/8")
SM38X270	1/4	12,7(1/2")
SM38Y270	3/8	12,7(1/2")
SM38Z270	1/2	12,7(1/2")

[ 228 ]



Cód.	Rosca	Tubo Ø
[Conex. Orientável em "L" c/ Rosca BSP + Oring]		
SM385040	M5	4
SM388040	1/8	4
SM384040	1/4	4
SM385050	M5	5
SM388050	1/8	5
SM384050	1/4	5
SM385060	M5	6
SM388060	1/8	6
SM384060	1/4	6
SM388080	1/8	8
SM384080	1/4	8
SM383080	3/8	8
SM382080	1/2	8
SM388100	1/8	10
SM384100	1/4	10
SM383100	3/8	10
SM382100	1/2	10
SM388120	1/8	12
SM384120	1/4	12
SM383120	3/8	12
SM382120	1/2	12
SM383140	3/8	14
SM382140	1/2	14
SM383160	3/8	16
SM382160	1/2	16

[ 240 ]



Cód.	Rosca	Tubo Ø
[Conex. Orient. Fêmea em "L" c/ Rosca BSPT - Teflon]		
SM178040T	1/8	4
SM174040T	1/4	4
SM178050T	1/8	5
SM174050T	1/4	5
SM178060T	1/8	6
SM174060T	1/4	6
SM178080T	1/8	8
SM174080T	1/4	8
SM173080T	3/8	8
SM172080T	1/2	8
SM178100T	1/8	10
SM174100T	1/4	10
SM173100T	3/8	10
SM172100T	1/2	10
SM178120T	1/8	12
SM174120T	1/4	12
SM173120T	3/8	12
SM172120T	1/2	12
SM173140T	3/8	14
SM172140T	1/2	14
SM173160T	3/8	16
SM172160T	1/2	16

[ 241 ]



Cód.	Rosca	Tubo Ø
[Con. Orient. Fêm. em "L" c/ Rosca BSPT-Teflon-Tubo INCH]		
SM178310T	1/8	3,18 (1/8")
SM174310T	1/4	3,18 (1/8")
SM178390T	1/8	3,97 (5/32")
SM174390T	1/4	3,97 (5/32")
SM178470T	1/8	4,76 (3/16")
SM174470T	1/4	4,76 (3/16")
SM173470T	3/8	4,76 (3/16")
SM178630T	1/8	6,35(1/4")
SM174630T	1/4	6,35(1/4")
SM173630T	3/8	6,35(1/4")
SM178790T	1/8	7,93(5/16")
SM174790T	1/4	7,93(5/16")
SM173790T	3/8	7,93(5/16")
SM172790T	1/2	7,93(5/16")
SM178950T	1/8	9,52(3/8")
SM174950T	1/4	9,52(3/8")
SM173950T	3/8	9,52(3/8")
SM172950T	1/2	9,52(3/8")
SM174270T	1/4	12,7(1/2")
SM173270T	3/8	12,7(1/2")
SM172270T	1/2	12,7(1/2")

[ 242 ]

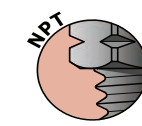
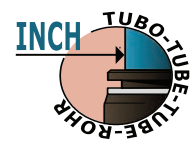

Cód.	Rosca	Tubo Ø
[Conex. Orient. Fêmea em "L" c/ Rosca NPT - Tubo INCH]		
SM17K310	1/8	3,18 (1/8")
SM17X310	1/4	3,18 (1/8")
SM17K390	1/8	3,97 (5/32")
SM17X390	1/4	3,97 (5/32")
SM17K470	1/8	4,76 (3/16")
SM17X470	1/4	4,76 (3/16")
SM17Y470	3/8	4,76 (3/16")
SM17K630	1/8	6,35(1/4")
SM17X630	1/4	6,35(1/4")
SM17Y630	3/8	6,35(1/4")
SM17U630	10-32UNF	6,35(1/4")
SM17K790	1/8	7,93(5/16")
SM17X790	1/4	7,93(5/16")
SM17Y790	3/8	7,93(5/16")
SM17Z790	1/2	7,93(5/16")
SM17K950	1/8	9,52(3/8")
SM17X950	1/4	9,52(3/8")
SM17Y950	3/8	9,52(3/8")
SM17Z950	1/2	9,52(3/8")
SM17X270	1/4	12,7(1/2")
SM17Y270	3/8	12,7(1/2")
SM17Z270	1/2	12,7(1/2")



[ 243 ]



Cód.	Rosca	Tubo Ø
[Conex.Orient.Fêmea em "L" c/ Rosca BSP+O'ring ]		
SM178048	1/8	4
SM174048	1/4	4
SM178058	1/8	5
SM174058	1/4	5
SM178068	1/8	6
SM174068	1/4	6
SM178088	1/8	8
SM174088	1/4	8
SM173088	3/8	8
SM172088	1/2	8
SM178108	1/8	10
SM174108	1/4	10
SM173108	3/8	10
SM172108	1/2	10
SM178128	1/8	12
SM174128	1/4	12
SM173128	3/8	12
SM172128	1/2	12
SM173148	3/8	14
SM172148	1/2	14
SM173168	3/8	16
SM172168	1/2	16

[ 244 ]



Cód.	Rosca	Tubo Ø
[Conex.Orientável Dupla em "L" c/ Rosca BSPT-Teflon ]		
SM908040T	1/8	4
SM904040T	1/4	4
SM908050T	1/8	5
SM904050T	1/4	5
SM908060T	1/8	6
SM904060T	1/4	6
SM908080T	1/8	8
SM904080T	1/4	8
SM903080T	3/8	8
SM902080T	1/2	8
SM908100T	1/8	10
SM904100T	1/4	10
SM903100T	3/8	10
SM902100T	1/2	10
SM908120T	1/8	12
SM904120T	1/4	12
SM903120T	3/8	12
SM902120T	1/2	12
SM903140T	3/8	14
SM902140T	1/2	14
SM903160T	3/8	16
SM902160T	1/2	16

[ 245 ]

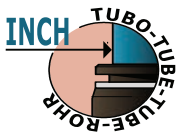

Cód.	Rosca	Tubo Ø
[Con.Orien.Dupla em "L" Rosca BSPT-Teflon-Tubo INCH]		
SM908310T	1/8	3,18 (1/8")
SM904310T	1/4	3,18 (1/8")
SM908390T	1/8	3,97 (5/32")
SM904390T	1/4	3,97 (5/32")
SM908470T	1/8	4,76 (3/16")
SM904470T	1/4	4,76 (3/16")
SM903470T	3/8	4,76 (3/16")
SM908630T	1/8	6,35(1/4")
SM904630T	1/4	6,35(1/4")
SM903630T	3/8	6,35(1/4")
SM908790T	1/8	7,93(5/16")
SM904790T	1/4	7,93(5/16")
SM903790T	3/8	7,93(5/16")
SM902790T	1/2	7,93(5/16")
SM908950T	1/8	9,52(3/8")
SM904950T	1/4	9,52(3/8")
SM903950T	3/8	9,52(3/8")
SM902950T	1/2	9,52(3/8")
SM904270T	1/4	12,7(1/2")
SM903270T	3/8	12,7(1/2")
SM902270T	1/2	12,7(1/2")

[ 246 ]

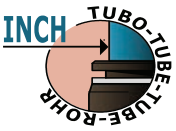

Cód.	Rosca	Tubo Ø
[Con.Orien.Dupla em "L" c/ Rosca NPT - Tubo INCH]		
SM90U310	10-32UNF	3,18(1/8")
SM90K310	1/8	3,18 (1/8")
SM90X310	1/4	3,18 (1/8")
SM90U390	10-32UNF	3,97 (5/32")
SM90K390	1/8	3,97 (5/32")
SM90X390	1/4	3,97 (5/32")
SM90U470	10-32UNF	4,76 (3/16")
SM90K470	1/8	4,76 (3/16")
SM90X470	1/4	4,76 (3/16")
SM90Y470	3/8	4,76 (3/16")
SM90U630	10-32UNF	6,35(1/4")
SM90K630	1/8	6,35(1/4")
SM90X630	1/4	6,35(1/4")
SM90Y630	3/8	6,35(1/4")
SM90K790	1/8	7,93(5/16")
SM90X790	1/4	7,93(5/16")
SM90Y790	3/8	7,93(5/16")
SM90Z790	1/2	7,93(5/16")
SM90K950	1/8	9,52(3/8")
SM90X950	1/4	9,52(3/8")
SM90Y950	3/8	9,52(3/8")
SM90Z950	1/2	9,52(3/8")
SM90X270	1/4	12,7(1/2")
SM90Y270	3/8	12,7(1/2")
SM90Z270	1/2	12,7(1/2")

[ 247 ]



Cód.	Rosca	Tubo Ø
[Conex.Orientável Dupla em "L" c/ Rosca BSP + O'ring ]		
SM905048	M5	4
SM908048	1/8	4
SM904048	1/4	4
SM905058	M5	5
SM908058	1/8	5
SM904058	1/4	5
SM905068	M5	6
SM908068	1/8	6
SM904068	1/4	6
SM908088	1/8	8
SM904088	1/4	8
SM903088	3/8	8
SM902088	1/2	8
SM908108	1/8	10
SM904108	1/4	10
SM903108	3/8	10
SM902108	1/2	10
SM908128	1/8	12
SM904128	1/4	12
SM903128	3/8	12
SM902128	1/2	12
SM903148	3/8	14
SM902148	1/2	14
SM903168	3/8	16
SM902168	1/2	16

[ 248 ]



Cód.	Rosca	Tubo Ø
[Conex.Orientável Tripla em "L" c/ Rosca BSPT-Teflon ]		
SM938040T	1/8	4
SM934040T	1/4	4
SM938050T	1/8	5
SM934050T	1/4	5
SM938060T	1/8	6
SM934060T	1/4	6
SM938080T	1/8	8
SM934080T	1/4	8
SM933080T	3/8	8
SM932080T	1/2	8
SM938100T	1/8	10
SM934100T	1/4	10
SM933100T	3/8	10
SM932100T	1/2	10
SM938120T	1/8	12
SM934120T	1/4	12
SM933120T	3/8	12
SM932120T	1/2	12
SM933140T	3/8	14
SM932140T	1/2	14
SM933160T	3/8	16
SM932160T	1/2	16

[ 249 ]

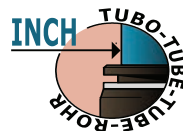

Cód.	Rosca	Tubo Ø
[Con.Orient.Tripla "L" c/ Rosca BSPT-Teflon-Tubo INCH]		
SM938310T	1/8	3,18 (1/8")
SM934310T	1/4	3,18 (1/8")
SM938390T	1/8	3,97 (5/32")
SM934390T	1/4	3,97 (5/32")
SM938470T	1/8	4,76 (3/16")
SM934470T	1/4	4,76 (3/16")
SM933470T	3/8	4,76 (3/16")
SM938630T	1/8	6,35(1/4")
SM934630T	1/4	6,35(1/4")
SM933630T	3/8	6,35(1/4")
SM938790T	1/8	7,93(5/16")
SM934790T	1/4	7,93(5/16")
SM933790T	3/8	7,93(5/16")
SM932790T	1/2	7,93(5/16")
SM938950T	1/8	9,52(3/8")
SM934950T	1/4	9,52(3/8")
SM933950T	3/8	9,52(3/8")
SM932950T	1/2	9,52(3/8")
SM934270T	1/4	12,7(1/2")
SM933270T	3/8	12,7(1/2")
SM932270T	1/2	12,7(1/2")

[ 250 ]

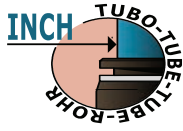

Cód.	Rosca	Tubo Ø
[Con.Orient.Tripla em "L" c/ Rosca NPT-Tubo INCH]		
SM93U310	10-32UNF	3,18(1/8")
SM93K310	1/8	3,18 (1/8")
SM93X310	1/4	3,18 (1/8")
SM93U390	10-32UNF	3,97 (5/32")
SM93K390	1/8	3,97 (5/32")
SM93X390	1/4	3,97 (5/32")
SM93U470	10-32UNF	4,76 (3/16")
SM93K470	1/8	4,76 (3/16")
SM93X470	1/4	4,76 (3/16")
SM93Y470	3/8	4,76 (3/16")
SM93U630	10-32UNF	6,35(1/4")
SM93K630	1/8	6,35(1/4")
SM93X630	1/4	6,35(1/4")
SM93Y630	3/8	6,35(1/4")
SM93K790	1/8	7,93(5/16")
SM93X790	1/4	7,93(5/16")
SM93Y790	3/8	7,93(5/16")
SM93Z790	1/2	7,93(5/16")
SM93K950	1/8	9,52(3/8")
SM93X950	1/4	9,52(3/8")
SM93Y950	3/8	9,52(3/8")
SM93Z950	1/2	9,52(3/8")
SM93X270	1/4	12,7(1/2")
SM93Y270	3/8	12,7(1/2")
SM93Z270	1/2	12,7(1/2")





[ 251 ]

Cód.	Rosca	Tubo Ø
<b>[Conex.Orientável Tripla em "L" c/ Rosca BSP + Oring ]</b>		
SM935048	M5	4
SM938048	1/8	4
SM934048	1/4	4
SM935058	M5	5
SM938058	1/8	5
SM934058	1/4	5
SM935068	M5	6
SM938068	1/8	6
SM934068	1/4	6
SM938088	1/8	8
SM934088	1/4	8
SM933088	3/8	8
SM932088	1/2	8
SM938108	1/8	10
SM934108	1/4	10
SM933108	3/8	10
SM932108	1/2	10
SM938128	1/8	12
SM934128	1/4	12
SM933128	3/8	12
SM932128	1/2	12
SM933148	3/8	14
SM932148	1/2	14
SM933168	3/8	16
SM932168	1/2	16



[ 210 ]

Cód.	Rosca	Tubo Ø
<b>[Conex. em "L" Giratório c/Rosca FÊMEA BSP ]</b>		
SM228040	1/8	4
SM224040	1/4	4
SM228050	1/8	5
SM224050	1/4	5
SM228060	1/8	6
SM224060	1/4	6
SM228080	1/8	8
SM224080	1/4	8
SM223080	3/8	8
SM222080	1/2	8
SM228100	1/8	10
SM224100	1/4	10
SM223100	3/8	10
SM222100	1/2	10
SM228120	1/8	12
SM224120	1/4	12
SM223120	3/8	12
SM222120	1/2	12
SM223140	3/8	14
SM222140	1/2	14
SM223160	3/8	16
SM222160	1/2	16



[ 252 ]

Cód.	Rosca	Tubo Ø
<b>[Conex.em "L" Giratório c/Rosca FÊMEA BSP-Tubo INCH]</b>		
SM228310	1/8	3,18 (1/8")
SM224310	1/4	3,18 (1/8")
SM228390	1/8	3,97 (5/32")
SM224390	1/4	3,97 (5/32")
SM228470	1/8	4,76 (3/16")
SM224470	1/4	4,76 (3/16")
SM223470	3/8	4,76 (3/16")
SM228630	1/8	6,35 (1/4")
SM224630	1/4	6,35 (1/4")
SM223630	3/8	6,35 (1/4")
SM228790	1/8	7,93 (5/16")
SM224790	1/4	7,93 (5/16")
SM223790	3/8	7,93 (5/16")
SM222790	1/2	7,93 (5/16")
SM228950	1/8	9,52 (3/8")
SM224950	1/4	9,52 (3/8")
SM223950	3/8	9,52 (3/8")
SM222950	1/2	9,52 (3/8")
SM224270	1/4	12,7 (1/2")
SM223270	3/8	12,7 (1/2")
SM222270	1/2	12,7 (1/2")

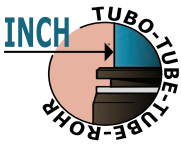

[ 253 ]

Cód.	Rosca	Tubo Ø
<b>[Conex.em "L" Giratório c/Rosca FÊMEA NPT-Tubo INCH]</b>		
SM22K310	1/8	3,18 (1/8")
SM22X310	1/4	3,18 (1/8")
SM22K390	1/8	3,97 (5/32")
SM22X390	1/4	3,97 (5/32")
SM22K470	1/8	4,76 (3/16")
SM22X470	1/4	4,76 (3/16")
SM22Y470	3/8	4,76 (3/16")
SM22K630	1/8	6,35 (1/4")
SM22X630	1/4	6,35 (1/4")
SM22Y630	3/8	6,35 (1/4")
SM22U630	10-32UNF	6,35 (1/4")
SM22K790	1/8	7,93 (5/16")
SM22X790	1/4	7,93 (5/16")
SM22Y790	3/8	7,93 (5/16")
SM22Z790	1/2	7,93 (5/16")
SM22K950	1/8	9,52 (3/8")
SM22X950	1/4	9,52 (3/8")
SM22Y950	3/8	9,52 (3/8")
SM22Z950	1/2	9,52 (3/8")
SM22X270	1/4	12,7 (1/2")
SM22Y270	3/8	12,7 (1/2")
SM22Z270	1/2	12,7 (1/2")

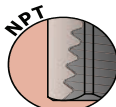
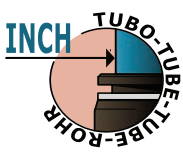

[ 306 ]

Cód.	Rosca	Tubo Ø
<b>[Conex.em "T" Lateral Giratório c/ Rosca BSPT - Teflon ]</b>		
SM338040T	1/8	4
SM334040T	1/4	4
SM338050T	1/8	5
SM334050T	1/4	5
SM338060T	1/8	6
SM334060T	1/4	6
SM338080T	1/8	8
SM334080T	1/4	8
SM333080T	3/8	8
SM332080T	1/2	8
SM338100T	1/8	10
SM334100T	1/4	10
SM333100T	3/8	10
SM332100T	1/2	10
SM338120T	1/8	12
SM334120T	1/4	12
SM333120T	3/8	12
SM332120T	1/2	12
SM333140T	3/8	14
SM332140T	1/2	14
SM333160T	3/8	16
SM332160T	1/2	16



[ 254 ]

Cód.	Rosca	Tubo Ø
<b>[Conex."T" Lat.Girat.c/ Rosca BSPT-Teflon-Tubo INCH ]</b>		
SM338310T	1/8	3,18 (1/8")
SM334310T	1/4	3,18 (1/8")
SM338390T	1/8	3,97 (5/32")
SM334390T	1/4	3,97 (5/32")
SM338470T	1/8	4,76 (3/16")
SM334470T	1/4	4,76 (3/16")
SM333470T	3/8	4,76 (3/16")
SM338630T	1/8	6,35 (1/4")
SM334630T	1/4	6,35 (1/4")
SM333630T	3/8	6,35 (1/4")
SM338790T	1/8	7,93 (5/16")
SM334790T	1/4	7,93 (5/16")
SM333790T	3/8	7,93 (5/16")
SM332790T	1/2	7,93 (5/16")
SM338950T	1/8	9,52 (3/8")
SM334950T	1/4	9,52 (3/8")
SM333950T	3/8	9,52 (3/8")
SM332950T	1/2	9,52 (3/8")
SM334270T	1/4	12,7 (1/2")
SM333270T	3/8	12,7 (1/2")
SM332270T	1/2	12,7 (1/2")

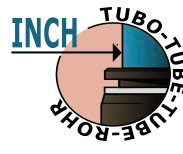

[ 255 ]

Cód.	Rosca	Tubo Ø
<b>[Con.em "T" Lateral Giratório c/ Rosca NPT Tubo INCH]</b>		
SM33U310	10-32UNF	3,18 (1/8")
SM33K310	1/8	3,18 (1/8")
SM33X310	1/4	3,18 (1/8")
SM33U390	10-32UNF	3,97 (5/32")
SM33K390	1/8	3,97 (5/32")
SM33X390	1/4	3,97 (5/32")
SM33U470	10-32UNF	4,76 (3/16")
SM33K470	1/8	4,76 (3/16")
SM33X470	1/4	4,76 (3/16")
SM33Y470	3/8	4,76 (3/16")
SM33U630	10-32UNF	6,35 (1/4")
SM33K630	1/8	6,35 (1/4")
SM33X630	1/4	6,35 (1/4")
SM33Y630	3/8	6,35 (1/4")
SM33K790	1/8	7,93 (5/16")
SM33X790	1/4	7,93 (5/16")
SM33Y790	3/8	7,93 (5/16")
SM33Z790	1/2	7,93 (5/16")
SM33K950	1/8	9,52 (3/8")
SM33X950	1/4	9,52 (3/8")
SM33Y950	3/8	9,52 (3/8")
SM33Z950	1/2	9,52 (3/8")
SM33X270	1/4	12,7 (1/2")
SM33Y270	3/8	12,7 (1/2")
SM33Z270	1/2	12,7 (1/2")

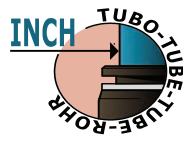

[ 305 ]

Cód.	Rosca	Tubo Ø
<b>[Conex.em "T" Lateral Giratório c/ Rosca BSP + Oring ]</b>		
SM335048	M5	4
SM338048	1/8	4
SM334048	1/4	4
SM335058	M5	5
SM338058	1/8	5
SM334058	1/4	5
SM335068	M5	6
SM338068	1/8	6
SM334068	1/4	6
SM338088	1/8	8
SM334088	1/4	8
SM333088	3/8	8
SM332088	1/2	8
SM338108	1/8	10
SM334108	1/4	10
SM333108	3/8	10
SM332108	1/2	10
SM338128	1/8	12
SM334128	1/4	12
SM333128	3/8	12
SM332128	1/2	12
SM333148	3/8	14
SM332148	1/2	14
SM333168	3/8	16
SM332168	1/2	16





[ 308 ]



Cód.	Rosca	Tubo Ø
<b>[Conex.em "T" Central Giratório c/ Rosca BSPT - Teflon]</b>		
SM408040T	1/8	4
SM404040T	1/4	4
SM408050T	1/8	5
SM404050T	1/4	5
SM405060T	M5	6
SM408060T	1/8	6
SM404060T	1/4	6
SM408080T	1/8	8
SM404080T	1/4	8
SM403080T	3/8	8
SM402080T	1/2	8
SM408100T	1/8	10
SM404100T	1/4	10
SM403100T	3/8	10
SM402100T	1/2	10
SM408120T	1/8	12
SM404120T	1/4	12
SM403120T	3/8	12
SM402120T	1/2	12
SM403140T	3/8	14
SM402140T	1/2	14
SM403160T	3/8	16
SM402160T	1/2	16

[ 309 ]

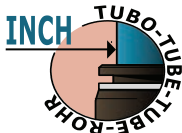

Cód.	Rosca	Tubo Ø
<b>[Con."T"Central Girat.c/Rosca BSPT-Teflon-Tubo INCH]</b>		
SM408310T	1/8	3,18 (1/8")
SM404310T	1/4	3,18 (1/8")
SM408390T	1/8	3,97 (5/32")
SM404390T	1/4	3,97 (5/32")
SM408470T	1/8	4,76 (3/16")
SM404470T	1/4	4,76 (3/16")
SM403470T	3/8	4,76 (3/16")
SM408630T	1/8	6,35(1/4")
SM404630T	1/4	6,35(1/4")
SM403630T	3/8	6,35(1/4")
SM408790T	1/8	7,93(5/16")
SM404790T	1/4	7,93(5/16")
SM403790T	3/8	7,93(5/16")
SM402790T	1/2	7,93(5/16")
SM408950T	1/8	9,52(3/8")
SM404950T	1/4	9,52(3/8")
SM403950T	3/8	9,52(3/8")
SM402950T	1/2	9,52(3/8")
SM404270T	1/4	12,7(1/2")
SM403270T	3/8	12,7(1/2")
SM402270T	1/2	12,7(1/2")

[ 310 ]

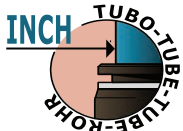

Cód.	Rosca	Tubo Ø
<b>[Conex.em "T" Central Girat. c/ Rosca NPT-Tubo INCH]</b>		
SM40U310	10-32UNF	3,18 (1/8")
SM40K310	1/8	3,18 (1/8")
SM40X310	1/4	3,18 (1/8")
SM40U390	10-32UNF	3,97 (5/32")
SM40K390	1/8	3,97 (5/32")
SM40X390	1/4	3,97 (5/32")
SM40U470	10-32UNF	4,76 (3/16")
SM40K470	1/8	4,76 (3/16")
SM40X470	1/4	4,76 (3/16")
SM40Y470	3/8	4,76 (3/16")
SM40U630	10-32UNF	6,35(1/4")
SM40K630	1/8	6,35(1/4")
SM40X630	1/4	6,35(1/4")
SM40Y630	3/8	6,35(1/4")
SM40K790	1/8	7,93(5/16")
SM40X790	1/4	7,93(5/16")
SM40Y790	3/8	7,93(5/16")
SM40Z790	1/2	7,93(5/16")
SM40K950	1/8	9,52(3/8")
SM40X950	1/4	9,52(3/8")
SM40Y950	3/8	9,52(3/8")
SM40Z950	1/2	9,52(3/8")
SM40X270	1/4	12,7(1/2")
SM40Y270	3/8	12,7(1/2")
SM40Z270	1/2	12,7(1/2")

[ 307 ]



Cód.	Rosca	Tubo Ø
<b>[Conex.em "T" Central Giratório c/Rosca BSP + Oring]</b>		
SM405048	M5	4
SM408048	1/8	4
SM404048	1/4	4
SM405058	M5	5
SM408058	1/8	5
SM404058	1/4	5
SM405068	M5	6
SM408068	1/8	6
SM404068	1/4	6
SM408088	1/8	8
SM404088	1/4	8
SM403088	3/8	8
SM402088	1/2	8
SM408108	1/8	10
SM404108	1/4	10
SM403108	3/8	10
SM402108	1/2	10
SM408128	1/8	12
SM404128	1/4	12
SM403128	3/8	12
SM402128	1/2	12
SM403148	3/8	14
SM402148	1/2	14
SM403168	3/8	16
SM402168	1/2	16

[ 311 ]



Cód.	Rosca	Tubo Ø
<b>[Conex.Orient.em "T" Central c/ Rosca BSPT-Teflon]</b>		
SM398040T	1/8	4
SM394040T	1/4	4
SM398050T	1/8	5
SM394050T	1/4	5
SM398060T	1/8	6
SM394060T	1/4	6
SM398080T	1/8	8
SM394080T	1/4	8
SM393080T	3/8	8
SM392080T	1/2	8
SM398100T	1/8	10
SM394100T	1/4	10
SM393100T	3/8	10
SM392100T	1/2	10
SM398120T	1/8	12
SM394120T	1/4	12
SM393120T	3/8	12
SM392120T	1/2	12
SM393140T	3/8	14
SM392140T	1/2	14
SM393160T	3/8	16
SM392160T	1/2	16

[ 312 ]

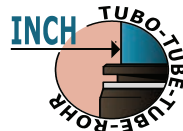

Cód.	Rosca	Tubo Ø
<b>[Con.Orien.em "T" Cent.c/Rosca BSPT-Teflon-Tubo INCH]</b>		
SM398310T	1/8	3,18 (1/8")
SM394310T	1/4	3,18 (1/8")
SM398390T	1/8	3,97 (5/32")
SM394390T	1/4	3,97 (5/32")
SM398470T	1/8	4,76 (3/16")
SM394470T	1/4	4,76 (3/16")
SM393470T	3/8	4,76 (3/16")
SM398630T	1/8	6,35(1/4")
SM394630T	1/4	6,35(1/4")
SM393630T	3/8	6,35(1/4")
SM398790T	1/8	7,93(5/16")
SM394790T	1/4	7,93(5/16")
SM393790T	3/8	7,93(5/16")
SM392790T	1/2	7,93(5/16")
SM398950T	1/8	9,52(3/8")
SM394950T	1/4	9,52(3/8")
SM393950T	3/8	9,52(3/8")
SM392950T	1/2	9,52(3/8")
SM394270T	1/4	12,7(1/2")
SM393270T	3/8	12,7(1/2")
SM392270T	1/2	12,7(1/2")

[ 313 ]

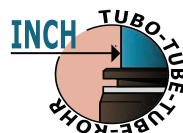

Cód.	Rosca	Tubo Ø
<b>[Conex.Orient.em "T" Central c/ Rosca NPT-Tubo INCH]</b>		
SM39U310	10-32UNF	3,18(1/8")
SM39K310	1/8	3,18 (1/8")
SM39X310	1/4	3,18 (1/8")
SM39U390	10-32UNF	3,97 (5/32")
SM39K390	1/8	3,97 (5/32")
SM39X390	1/4	3,97 (5/32")
SM39U470	10-32UNF	4,76 (3/16")
SM39K470	1/8	4,76 (3/16")
SM39X470	1/4	4,76 (3/16")
SM39Y470	3/8	4,76 (3/16")
SM39U630	10-32UNF	6,35(1/4")
SM39K630	1/8	6,35(1/4")
SM39X630	1/4	6,35(1/4")
SM39Y630	3/8	6,35(1/4")
SM39K790	1/8	7,93(5/16")
SM39X790	1/4	7,93(5/16")
SM39Y790	3/8	7,93(5/16")
SM39Z790	1/2	7,93(5/16")
SM39K950	1/8	9,52(3/8")
SM39X950	1/4	9,52(3/8")
SM39Y950	3/8	9,52(3/8")
SM39Z950	1/2	9,52(3/8")
SM39X270	1/4	12,7(1/2")
SM39Y270	3/8	12,7(1/2")
SM39Z270	1/2	12,7(1/2")



[ 314 ]



Cód.	Rosca	Tubo Ø
<b>[Conex.Orient.em "T" Central c/ Rosca BSP + O'ring ]</b>		
SM395040	M5	4
SM398040	1/8	4
SM394040	1/4	4
SM395050	M5	5
SM398050	1/8	5
SM394050	1/4	5
SM395060	M5	6
SM398060	1/8	6
SM394060	1/4	6
SM398080	1/8	8
SM394080	1/4	8
SM393080	3/8	8
SM392080	1/2	8
SM398100	1/8	10
SM394100	1/4	10
SM393100	3/8	10
SM392100	1/2	10
SM398120	1/8	12
SM394120	1/4	12
SM393120	3/8	12
SM392120	1/2	12
SM393140	3/8	14
SM392140	1/2	14
SM393160	3/8	16
SM392160	1/2	16

[ 315 ]



Cód.	Rosca	Tubo Ø
<b>[Con.Orient.em "T" Central Duplo c/Rosca BSPT-Teflon]</b>		
SM118040T	1/8	4
SM114040T	1/4	4
SM118050T	1/8	5
SM114050T	1/4	5
SM118060T	1/8	6
SM114060T	1/4	6
SM118080T	1/8	8
SM114080T	1/4	8
SM113080T	3/8	8
SM112080T	1/2	8
SM118100T	1/8	10
SM114100T	1/4	10
SM113100T	3/8	10
SM112100T	1/2	10
SM118120T	1/8	12
SM114120T	1/4	12
SM113120T	3/8	12
SM112120T	1/2	12
SM113140T	3/8	14
SM112140T	1/2	14
SM113160T	3/8	16
SM112160T	1/2	16

[ 316 ]



Cód.	Rosca	Tubo Ø
<b>[Con.Ori."T" Cen.Duplo c/Rosca BSPT-Teflon-Tubo INCH]</b>		
SM118310T	1/8	3,18 (1/8")
SM114310T	1/4	3,18 (1/8")
SM118390T	1/8	3,97 (5/32")
SM114390T	1/4	3,97 (5/32")
SM118470T	1/8	4,76 (3/16")
SM114470T	1/4	4,76 (3/16")
SM113470T	3/8	4,76 (3/16")
SM118630T	1/8	6,35 (1/4")
SM114630T	1/4	6,35 (1/4")
SM113630T	3/8	6,35 (1/4")
SM118790T	1/8	7,93 (5/16")
SM114790T	1/4	7,93 (5/16")
SM113790T	3/8	7,93 (5/16")
SM112790T	1/2	7,93 (5/16")
SM118950T	1/8	9,52 (3/8")
SM114950T	1/4	9,52 (3/8")
SM113950T	3/8	9,52 (3/8")
SM112950T	1/2	9,52 (3/8")
SM114270T	1/4	12,7 (1/2")
SM113270T	3/8	12,7 (1/2")
SM112270T	1/2	12,7 (1/2")

[ 317 ]



Cód.	Rosca	Tubo Ø
<b>[Con.Orient."T" Centr. Duplo c/ Rosca NPT - Tubo INCH]</b>		
SM11U310	10-32UNF	3,18 (1/8")
SM11K310	1/8	3,18 (1/8")
SM11X310	1/4	3,18 (1/8")
SM11U390	10-32UNF	3,97 (5/32")
SM11K390	1/8	3,97 (5/32")
SM11X390	1/4	3,97 (5/32")
SM11U470	10-32UNF	4,76 (3/16")
SM11K470	1/8	4,76 (3/16")
SM11X470	1/4	4,76 (3/16")
SM11Y470	3/8	4,76 (3/16")
SM11U630	10-32UNF	6,35 (1/4")
SM11K630	1/8	6,35 (1/4")
SM11X630	1/4	6,35 (1/4")
SM11Y630	3/8	6,35 (1/4")
SM11K790	1/8	7,93 (5/16")
SM11X790	1/4	7,93 (5/16")
SM11Y790	3/8	7,93 (5/16")
SM11Z790	1/2	7,93 (5/16")
SM11K950	1/8	9,52 (3/8")
SM11X950	1/4	9,52 (3/8")
SM11Y950	3/8	9,52 (3/8")
SM11Z950	1/2	9,52 (3/8")
SM11X270	1/4	12,7 (1/2")
SM11Y270	3/8	12,7 (1/2")
SM11Z270	1/2	12,7 (1/2")

[ 318 ]



Cód.	Rosca	Tubo Ø
<b>[Conex. Orient. "T" Central Duplo c/Rosca BSP + O'ring ]</b>		
SM115048	M5	4
SM118048	1/8	4
SM114048	1/4	4
SM115058	M5	5
SM118058	1/8	5
SM114058	1/4	5
SM115068	M5	6
SM118068	1/8	6
SM114068	1/4	6
SM118088	1/8	8
SM114088	1/4	8
SM113088	3/8	8
SM112088	1/2	8
SM118108	1/8	10
SM114108	1/4	10
SM113108	3/8	10
SM112108	1/2	10
SM118128	1/8	12
SM114128	1/4	12
SM113128	3/8	12
SM112128	1/2	12
SM113148	3/8	14
SM112148	1/2	14
SM113168	3/8	16
SM112168	1/2	16

[ 319 ]



Cód.	Rosca	Tubo Ø
<b>[Con.Orient.em "T" Central Triplo c/ Rosca BSPT-Teflon]</b>		
SM578040T	1/8	4
SM574040T	1/4	4
SM578050T	1/8	5
SM574050T	1/4	5
SM578060T	1/8	6
SM574060T	1/4	6
SM578080T	1/8	8
SM574080T	1/4	8
SM573080T	3/8	8
SM572080T	1/2	8
SM578100T	1/8	10
SM574100T	1/4	10
SM573100T	3/8	10
SM572100T	1/2	10
SM578120T	1/8	12
SM574120T	1/4	12
SM573120T	3/8	12
SM572120T	1/2	12
SM573140T	3/8	14
SM572140T	1/2	14
SM573160T	3/8	16
SM572160T	1/2	16

[ 320 ]

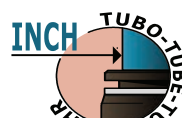

Cód.	Rosca	Tubo Ø
<b>[Con.Orient.em "T" Cent. Triplo Rosca BSPT-Teflon-Tubo INCH]</b>		
SM578310T	1/8	3,18 (1/8")
SM574310T	1/4	3,18 (1/8")
SM578390T	1/8	3,97 (5/32")
SM574390T	1/4	3,97 (5/32")
SM578470T	1/8	4,76 (3/16")
SM574470T	1/4	4,76 (3/16")
SM573470T	3/8	4,76 (3/16")
SM578630T	1/8	6,35 (1/4")
SM574630T	1/4	6,35 (1/4")
SM573630T	3/8	6,35 (1/4")
SM578790T	1/8	7,93 (5/16")
SM574790T	1/4	7,93 (5/16")
SM573790T	3/8	7,93 (5/16")
SM572790T	1/2	7,93 (5/16")
SM578950T	1/8	9,52 (3/8")
SM574950T	1/4	9,52 (3/8")
SM573950T	3/8	9,52 (3/8")
SM572950T	1/2	9,52 (3/8")
SM574270T	1/4	12,7 (1/2")
SM573270T	3/8	12,7 (1/2")
SM572270T	1/2	12,7 (1/2")

[ 321 ]

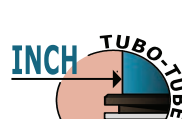



Cód.	Rosca	Tubo Ø
<b>[Con.Orient.em "T" Centr. Triplo c/ Rosca NPT-Tubo INCH]</b>		
SM57U310	10-32UNF	3,18 (1/8")
SM57K310	1/8	3,18 (1/8")
SM57X310	1/4	3,18 (1/8")
SM57U390	10-32UNF	3,97 (5/32")
SM57K390	1/8	3,97 (5/32")
SM57X390	1/4	3,97 (5/32")
SM57U470	10-32UNF	4,76 (3/16")
SM57K470	1/8	4,76 (3/16")
SM57X470	1/4	4,76 (3/16")
SM57Y470	3/8	4,76 (3/16")
SM57U630	10-32UNF	6,35 (1/4")
SM57K630	1/8	6,35 (1/4")
SM57X630	1/4	6,35 (1/4")
SM57Y630	3/8	6,35 (1/4")
SM57K790	1/8	7,93 (5/16")
SM57X790	1/4	7,93 (5/16")
SM57Y790	3/8	7,93 (5/16")
SM57Z790	1/2	7,93 (5/16")
SM57K950	1/8	9,52 (3/8")
SM57X950	1/4	9,52 (3/8")
SM57Y950	3/8	9,52 (3/8")
SM57Z950	1/2	9,52 (3/8")
SM57X270	1/4	12,7 (1/2")
SM57Y270	3/8	12,7 (1/2")
SM57Z270	1/2	12,7 (1/2")







**[ 322 ]** [Conex.Orient.em "T" Central Triplo c/Rosca BSP+O'ring]

Cód.	Rosca	Tubo Ø
SM575048	M5	4
SM578048	1/8	4
SM574048	1/4	4
SM575058	M5	5
SM578058	1/8	5
SM574058	1/4	5
SM575068	M5	6
SM578068	1/8	6
SM574068	1/4	6
SM578088	1/8	8
SM574088	1/4	8
SM573088	3/8	8
SM572088	1/2	8
SM578108	1/8	10
SM574108	1/4	10
SM573108	3/8	10
SM572108	1/2	10
SM578128	1/8	12
SM574128	1/4	12
SM573128	3/8	12
SM572128	1/2	12
SM573148	3/8	14
SM572148	1/2	14
SM573168	3/8	16
SM572168	1/2	16



**[ 323 ]** [Conex.em "Y" Central Giratório c/ Rosca BSPT - Teflon]

Cód.	Rosca	Tubo Ø
SM348040T	1/8	4
SM344040T	1/4	4
SM348050T	1/8	5
SM344050T	1/4	5
SM348060T	1/8	6
SM344060T	1/4	6
SM348080T	1/8	8
SM344080T	1/4	8
SM343080T	3/8	8
SM342080T	1/2	8
SM348100T	1/8	10
SM344100T	1/4	10
SM343100T	3/8	10
SM342100T	1/2	10
SM348120T	1/8	12
SM344120T	1/4	12
SM343120T	3/8	12
SM342120T	1/2	12
SM343140T	3/8	14
SM342140T	1/2	14
SM343160T	3/8	16
SM342160T	1/2	16



**[ 324 ]** [Conex."Y"Cent.Girat. c/Rosca BSPT-Teflon-Tubo INCH]

Cód.	Rosca	Tubo Ø
SM348310T	1/8	3,18 (1/8")
SM344310T	1/4	3,18 (1/8")
SM348390T	1/8	3,97 (5/32")
SM344390T	1/4	3,97 (5/32")
SM348470T	1/8	4,76 (3/16")
SM344470T	1/4	4,76 (3/16")
SM343470T	3/8	4,76 (3/16")
SM348630T	1/8	6,35(1/4")
SM344630T	1/4	6,35(1/4")
SM343630T	3/8	6,35(1/4")
SM348790T	1/8	7,93(5/16")
SM344790T	1/4	7,93(5/16")
SM343790T	3/8	7,93(5/16")
SM342790T	1/2	7,93(5/16")
SM348950T	1/8	9,52(3/8")
SM344950T	1/4	9,52(3/8")
SM343950T	3/8	9,52(3/8")
SM342950T	1/2	9,52(3/8")
SM344270T	1/4	12,7(1/2")
SM343270T	3/8	12,7(1/2")
SM342270T	1/2	12,7(1/2")



**[ 325 ]** [Conex.em "Y" Central Girat.c/ Rosca NPT-Tubo INCH]

Cód.	Rosca	Tubo Ø
SM34U310	10-32UNF	3,18 (1/8")
SM34K310	1/8	3,18 (1/8")
SM34X310	1/4	3,18 (1/8")
SM34U390	10-32UNF	3,97 (5/32")
SM34K390	1/8	3,97 (5/32")
SM34X390	1/4	3,97 (5/32")
SM34U470	10-32UNF	4,76 (3/16")
SM34K470	1/8	4,76 (3/16")
SM34X470	1/4	4,76 (3/16")
SM34Y470	3/8	4,76 (3/16")
SM34U630	10-32UNF	6,35(1/4")
SM34K630	1/8	6,35(1/4")
SM34X630	1/4	6,35(1/4")
SM34Y630	3/8	6,35(1/4")
SM34K790	1/8	7,93(5/16")
SM34X790	1/4	7,93(5/16")
SM34Y790	3/8	7,93(5/16")
SM34Z790	1/2	7,93(5/16")
SM34K950	1/8	9,52(3/8")
SM34X950	1/4	9,52(3/8")
SM34Y950	3/8	9,52(3/8")
SM34Z950	1/2	9,52(3/8")
SM34X270	1/4	12,7(1/2")
SM34Y270	3/8	12,7(1/2")
SM34Z270	1/2	12,7(1/2")

**[ 326 ]** [Conex.em "Y" Central Giratório c/ Rosca BSP + O'ring]

Cód.	Rosca	Tubo Ø
SM345048	M5	4
SM348048	1/8	4
SM344048	1/4	4
SM345058	M5	5
SM348058	1/8	5
SM344058	1/4	5
SM345068	M5	6
SM348068	1/8	6
SM344068	1/4	6
SM348088	1/8	8
SM344088	1/4	8
SM343088	3/8	8
SM342088	1/2	8
SM348108	1/8	10
SM344108	1/4	10
SM343108	3/8	10
SM342108	1/2	10
SM348128	1/8	12
SM344128	1/4	12
SM343128	3/8	12
SM342128	1/2	12
SM343148	3/8	14
SM342148	1/2	14
SM343168	3/8	16
SM342168	1/2	16

**[ 411 ]** [ União Reta ]

Cód.	Tubo Ø
SM500031	3
SM500041	4
SM500051	5
SM500061	6
SM500081	8
SM500101	10
SM500121	12
SM500141	14
SM500161	16



**[ 327 ]** [ União Reta - Tubo INCH ]

Cód.	Tubo Ø
SM500311	3,18 (1/8")
SM500391	3,97 (5/32")
SM500471	4,76 (3/16")
SM500631	6,35(1/4")
SM500791	7,93(5/16")
SM500951	9,52(3/8")
SM500271	12,7(1/2")

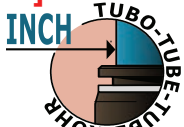

**[ 413 ]** [ União em "L" ]

Cód.	Tubo Ø
SM600030	3
SM600040	4
SM600050	5
SM600060	6
SM600080	8
SM600100	10
SM600120	12
SM600140	14
SM600160	16



**[ 328 ]** [ União em "L" - Tubo INCH ]

Cód.	Tubo Ø
SM600310	3,18 (1/8")
SM600390	3,97 (5/32")
SM600470	4,76 (3/16")
SM600630	6,35(1/4")
SM600790	7,93(5/16")
SM600950	9,52(3/8")
SM600270	12,7(1/2")



**[ 414 ]** [ União em "T" ]

Cód.	Tubo Ø
SM700030	3
SM700040	4
SM700050	5
SM700060	6
SM700080	8
SM700100	10
SM700120	12
SM700140	14
SM700160	16



**[ 329 ]** [ União em "T" - Tubo INCH ]

Cód.	Tubo Ø
SM700310	3,18 (1/8")
SM700390	3,97 (5/32")
SM700470	4,76 (3/16")
SM700630	6,35(1/4")
SM700790	7,93(5/16")
SM700950	9,52(3/8")
SM700270	12,7(1/2")

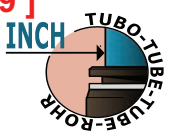



	Cód.	Tube A Ø	Tube B Ø
<b>[ 330 ]</b> 	[ União em "T" com Redução ]		
	SM754060	4	6
	SM754080	4	8
	SM756080	6	8
	SM756100	6	10
	SM758100	8	10
	SM758120	8	12
	SM751120	10	12
	SM751140	10	14
	SM752140	12	14
	SM752160	12	16
<b>[ 331 ]</b> 	[ União em "T" com Redução - Tubo INCH ]		
	SM7539630	3,97 (5/32")	6,35(1/4")
	SM7531630	3,18 (1/8")	6,35(1/4")
	SM7539470	3,97 (5/32")	4,76 (3/16")
	SM7563790	6,35(1/4")	7,93(5/16")
	SM7563950	6,35(1/4")	9,52(3/8")
	SM7579950	7,93(5/16")	9,52(3/8")
	SM7595270	9,52(3/8")	12,7(1/2")

	Cód.	Tube Ø
<b>[ 410 ]</b> 	[ União em "X" ]	
	SM260030	3
	SM260040	4
	SM260050	5
	SM260060	6
	SM260080	8
	SM260100	10
	SM260120	12
	SM260140	14
	SM260160	16
<b>[ 332 ]</b> 	[ União em "X" - Tubo INCH ]	
	SM260310	3,18 (1/8")
	SM260390	3,97 (5/32")
	SM260470	4,76 (3/16")
	SM260630	6,35(1/4")
	SM260790	7,93(5/16")
	SM260950	9,52(3/8")
SM260270	12,7(1/2")	
<b>[ 412 ]</b> 	[ União em "Y" ]	
	SM510031	3
	SM510041	4
	SM510051	5
	SM510061	6
	SM510081	8
	SM510101	10
	SM510121	12
	SM510141	14
	SM510161	16
<b>[ 333 ]</b> 	[ União em "Y" - Tubo INCH ]	
	SM510311	3,18 (1/8")
	SM510391	3,97 (5/32")
	SM510471	4,76 (3/16")
	SM510631	6,35(1/4")
	SM510791	7,93(5/16")
	SM510951	9,52(3/8")
	SM510271	12,7(1/2")

	Cód.	Tube A Ø	Tube B Ø	
<b>[ 409 ]</b> 	[ União de Redução Retá ]			
	SM244061	4	6	
	SM244081	4	8	
	SM246080	6	8	
	SM246101	6	10	
	SM248101	8	10	
	SM248121	8	12	
	SM241121	10	12	
	SM241141	10	14	
	SM242141	12	14	
	SM242161	12	16	
	<b>[ 334 ]</b> 	[ União de Redução Retá - Tubo INCH ]		
		SM2439631	3,97 (5/32")	6,35(1/4")
		SM2431631	3,18 (1/8")	6,35(1/4")
SM2439471		3,97 (5/32")	4,76 (3/16")	
SM2463791		6,35(1/4")	7,93(5/16")	
SM2463951		6,35(1/4")	9,52(3/8")	
SM2479951		7,93(5/16")	9,52(3/8")	
SM2495271	9,52(3/8")	12,7(1/2")		
<b>[ 802 ]</b> 	[ Inserto Redutor ]			
	SM254061	4	6	
	SM254081	4	8	
	SM256081	6	8	
	SM256101	6	10	
	SM258101	8	10	
	SM256121	6	12	
	SM258121	8	12	
SM251121	10	12		
<b>[ 339 ]</b> 	[ Inserto Redutor - Tubo INCH ]			
	SM2539631	3,97 (5/32")	6,35(1/4")	
	SM2539791	3,97 (5/32")	7,93(5/16")	
	SM2563791	6,35(1/4")	7,93(5/16")	
	SM2563951	6,35(1/4")	9,52(3/8")	
	SM2579951	7,93(5/16")	9,52(3/8")	
SM2563271	6,35(1/4")	12,7(1/2")		

	Cód.	Rosca	Tube Ø
<b>[ 340 ]</b> 	[ Inserto Reto Rosca FÊMEA BSP ]		
	SM648041	1/8	4
	SM644041	1/4	4
	SM648051	1/8	5
	SM644051	1/4	5
	SM648061	1/8	6
	SM644061	1/4	6
	SM648081	1/8	8
	SM644081	1/4	8
	SM643081	3/8	8
	SM642081	1/2	8
	SM648101	1/8	10
	SM644101	1/4	10
	SM643101	3/8	10
	SM642101	1/2	10
	SM648121	1/8	12
	SM644121	1/4	12
	SM643121	3/8	12
	SM642121	1/2	12
	SM643141	3/8	14
SM642141	1/2	14	
SM643161	3/8	16	
SM642161	1/2	16	
<b>[ 341 ]</b> 	[ Inserto Reto Rosca FÊMEA BSP - Tubo INCH ]		
	SM648311	1/8	3,18 (1/8")
	SM644311	1/4	3,18 (1/8")
	SM648391	1/8	3,97 (5/32")
	SM644391	1/4	3,97 (5/32")
	SM648471	1/8	4,76 (3/16")
	SM644471	1/4	4,76 (3/16")
	SM643471	3/8	4,76 (3/16")
	SM648631	1/8	6,35(1/4")
	SM644631	1/4	6,35(1/4")
	SM643631	3/8	6,35(1/4")
	SM648791	1/8	7,93(5/16")
	SM644791	1/4	7,93(5/16")
	SM643791	3/8	7,93(5/16")
	SM642791	1/2	7,93(5/16")
	SM648951	1/8	9,52(3/8")
	SM644951	1/4	9,52(3/8")
	SM643951	3/8	9,52(3/8")
	SM642951	1/2	9,52(3/8")
	SM644271	1/4	12,7(1/2")
SM643271	3/8	12,7(1/2")	
SM642271	1/2	12,7(1/2")	
<b>[ 342 ]</b> 	[ Inserto Reto Rosca FÊMEA NPT - Tubo INCH ]		
	SM64K311	1/8	3,18 (1/8")
	SM64X311	1/4	3,18 (1/8")
	SM64K391	1/8	3,97 (5/32")
	SM64X391	1/4	3,97 (5/32")
	SM64K471	1/8	4,76 (3/16")
	SM64X471	1/4	4,76 (3/16")
	SM64Y471	3/8	4,76 (3/16")
	SM64K631	1/8	6,35(1/4")
	SM64Y631	3/8	6,35(1/4")
	SM64U631	10-32UNF	6,35(1/4")
	SM64K791	1/8	7,93(5/16")
	SM64X791	1/4	7,93(5/16")
	SM64Y791	3/8	7,93(5/16")
	SM64Z791	1/2	7,93(5/16")
	SM64K951	1/8	9,52(3/8")
	SM64X951	1/4	9,52(3/8")
	SM64Y951	3/8	9,52(3/8")
	SM64Z951	1/2	9,52(3/8")
	SM64X271	1/4	12,7(1/2")
SM64Y271	3/8	12,7(1/2")	
SM64Z271	1/2	12,7(1/2")	



**[ 343 ]**



Cód.	Tubo A Ø	Tubo B Ø
[ Inseto em "L" c/ Espiga ]		
SM540041	4	4
SM540051	5	5
SM540061	6	6
SM540081	8	8
SM540101	10	10
SM540121	12	12
SM540141	14	14
SM540161	16	16

**[ 344 ]**



Cód.	Tubo A Ø	Tubo B Ø
[ Inseto em "L" c/ Espiga-Tubo INCH ]		
SM540311	3,18 (1/8")	3,18 (1/8")
SM540391	3,97 (5/32")	3,97 (5/32")
SM540471	4,76 (3/16")	4,76 (3/16")
SM540631	6,35 (1/4")	6,35 (1/4")
SM540791	7,93 (5/16")	7,93 (5/16")
SM540951	9,52 (3/8")	9,52 (3/8")
SM540271	12,7 (1/2")	12,7 (1/2")

**[ 345 ]**

Cód.	Tubo A Ø	Tubo B Ø
[ Inseto Redutor em "L" c/ Espiga ]		
SM544061	4	6
SM544081	4	8
SM546081	6	8
SM546101	6	10
SM548101	8	10
SM546121	6	12
SM548121	8	12
SM541121	10	12

**[ 304 ]**



Cód.	Tubo A Ø	Tubo B Ø
[ Inseto Red. "L" Espiga-Tubo INCH ]		
SM5439631	3,97 (5/32")	6,35 (1/4")
SM5439791	3,97 (5/32")	7,93 (5/16")
SM5463791	6,35 (1/4")	7,93 (5/16")
SM5463951	6,35 (1/4")	9,52 (3/8")
SM5479951	7,93 (5/16")	9,52 (3/8")
SM5463271	6,35 (1/4")	12,7 (1/2")

**[ 346 ]**



Cód.	Tubo A Ø	Tubo B Ø
[ Inseto em "T" Central c/ Espiga ]		
SM570041	4	4
SM570051	5	5
SM570061	6	6
SM570081	8	8
SM570101	10	10
SM570121	12	12
SM570141	14	14
SM570161	16	16

**[ 347 ]**

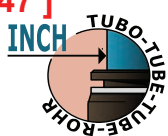

Cód.	Tubo A Ø	Tubo B Ø
[ Inseto "T" Centr. c/ Espiga-Tubo INCH ]		
SM570311	3,18 (1/8")	3,18 (1/8")
SM570391	3,97 (5/32")	3,97 (5/32")
SM570471	4,76 (3/16")	4,76 (3/16")
SM570631	6,35 (1/4")	6,35 (1/4")
SM570791	7,93 (5/16")	7,93 (5/16")
SM570951	9,52 (3/8")	9,52 (3/8")
SM570271	12,7 (1/2")	12,7 (1/2")

**[ 348 ]**

Cód.	Tubo A Ø	Tubo B Ø
[ Inseto Redutor em "T" Central c/ Espiga ]		
SM574061	4	6
SM574081	4	8
SM576081	6	8
SM576101	6	10
SM578101	8	10
SM576121	6	12
SM578121	8	12
SM571121	10	12

**[ 349 ]**



Cód.	Tubo A Ø	Tubo B Ø
[ Inseto Redutor em "T" Central c/ Espiga - Tubo INCH ]		
SM5739631	3,97 (5/32")	6,35 (1/4")
SM5739791	3,97 (5/32")	7,93 (5/16")
SM5763791	6,35 (1/4")	7,93 (5/16")
SM5763951	6,35 (1/4")	9,52 (3/8")
SM5779951	7,93 (5/16")	9,52 (3/8")
SM5763271	6,35 (1/4")	12,7 (1/2")

**[ 350 ]**



Cód.	Tubo A Ø	Tubo B Ø
[ Inseto em "T" Lateral c/ Espiga ]		
SM580041	4	4
SM580051	5	5
SM580061	6	6
SM580081	8	8
SM580101	10	10
SM580121	12	12
SM580141	14	14
SM580161	16	16

**[ 351 ]**

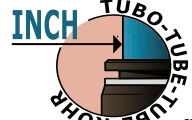

Cód.	Tubo A Ø	Tubo B Ø
[ Inseto "T" Lat. c/ Espiga-Tubo INCH ]		
SM580311	3,18 (1/8")	3,18 (1/8")
SM580391	3,97 (5/32")	3,97 (5/32")
SM580471	4,76 (3/16")	4,76 (3/16")
SM580631	6,35 (1/4")	6,35 (1/4")
SM580791	7,93 (5/16")	7,93 (5/16")
SM580951	9,52 (3/8")	9,52 (3/8")
SM580271	12,7 (1/2")	12,7 (1/2")

**[ 352 ]**

Cód.	Tubo A Ø	Tubo B Ø
[ Inseto Redutor em "T" Lateral c/ Espiga ]		
SM584061	4	6
SM584081	4	8
SM586081	6	8
SM586101	6	10
SM588101	8	10
SM586121	6	12
SM588121	8	12
SM581121	10	12

**[ 353 ]**



Cód.	Tubo A Ø	Tubo B Ø
[ Inseto Red. "T" Lat. Espiga-Tubo INCH ]		
SM5839631	3,97 (5/32")	6,35 (1/4")
SM5839791	3,97 (5/32")	7,93 (5/16")
SM5863791	6,35 (1/4")	7,93 (5/16")
SM5863951	6,35 (1/4")	9,52 (3/8")
SM5879951	7,93 (5/16")	9,52 (3/8")
SM5863271	6,35 (1/4")	12,7 (1/2")

**[ 354 ]**



Cód.	Tubo A Ø	Tubo B Ø
[ Inseto em "Y" Central c/ Espiga ]		
SM530041	4	4
SM530051	5	5
SM530061	6	6
SM530081	8	8
SM530101	10	10
SM530121	12	12
SM530141	14	14
SM530161	16	16

**[ 355 ]**



Cód.	Tubo A Ø	Tubo B Ø
[ Inseto "Y" Cent. c/ Espiga-Tubo INCH ]		
SM530311	3,18 (1/8")	3,18 (1/8")
SM530391	3,97 (5/32")	3,97 (5/32")
SM530471	4,76 (3/16")	4,76 (3/16")
SM530631	6,35 (1/4")	6,35 (1/4")
SM530791	7,93 (5/16")	7,93 (5/16")
SM530951	9,52 (3/8")	9,52 (3/8")
SM530271	12,7 (1/2")	12,7 (1/2")

**[ 356 ]**

Cód.	Tubo A Ø	Tubo B Ø
[ Inseto Redutor em "Y" Central c/ Espiga ]		
SM534061	4	6
SM534081	4	8
SM536081	6	8
SM536101	6	10
SM538101	8	10
SM536121	6	12
SM538121	8	12
SM531121	10	12

**[ 357 ]**



Cód.	Tubo A Ø	Tubo B Ø
[ Inseto Red. "Y" Cen. Espiga-Tubo INCH ]		
SM5339631	3,97 (5/32")	6,35 (1/4")
SM5339791	3,97 (5/32")	7,93 (5/16")
SM5363791	6,35 (1/4")	7,93 (5/16")
SM5363951	6,35 (1/4")	9,52 (3/8")
SM5379951	7,93 (5/16")	9,52 (3/8")
SM5363271	6,35 (1/4")	12,7 (1/2")

**[ 415 ]**



Cód.	Tubo Ø
[ União Reta Tubo/Tubo p/ Painel ]	
SM800030	3
SM800040	4
SM800050	5
SM800060	6
SM800080	8
SM800100	10
SM800120	12
SM800140	14
SM800160	16

**[ 358 ]**





Cód.	Tubo Ø
[ União Reta Tubo/Tubo p/ Painel-Tubo INCH ]	
SM800310	3,18 (1/8")
SM800390	3,97 (5/32")
SM800470	4,76 (3/16")
SM800630	6,35 (1/4")
SM800790	7,93 (5/16")
SM800950	9,52 (3/8")
SM800270	12,7 (1/2")







**[ 359 ]**

Cód.	Rosca	Tubo Ø
<b>[União Reta p/ Painel c/Rosca FÊMEA BSP]</b>		
SM818040	1/8	4
SM814040	1/4	4
SM818050	1/8	5
SM814050	1/4	5
SM818060	1/8	6
SM814060	1/4	6
SM818080	1/8	8
SM814080	1/4	8
SM813080	3/8	8
SM812080	1/2	8
SM818100	1/8	10
SM814100	1/4	10
SM813100	3/8	10
SM812100	1/2	10
SM818120	1/8	12
SM814120	1/4	12
SM813120	3/8	12
SM812120	1/2	12
SM813140	3/8	14
SM812140	1/2	14
SM813160	3/8	16
SM812160	1/2	16

**[ 360 ]**

Cód.	Rosca	Tubo Ø
<b>[União Reta p/Painel c/Rosca FÊMEA BSP - Tubo INCH ]</b>		
SM818310	1/8	3,18 (1/8")
SM814310	1/4	3,18 (1/8")
SM818390	1/8	3,97 (5/32")
SM814390	1/4	3,97 (5/32")
SM818470	1/8	4,76 (3/16")
SM814470	1/4	4,76 (3/16")
SM813470	3/8	4,76 (3/16")
SM818630	1/8	6,35(1/4")
SM814630	1/4	6,35(1/4")
SM813630	3/8	6,35(1/4")
SM818790	1/8	7,93(5/16")
SM814790	1/4	7,93(5/16")
SM813790	3/8	7,93(5/16")
SM812790	1/2	7,93(5/16")
SM818950	1/8	9,52(3/8")
SM814950	1/4	9,52(3/8")
SM813950	3/8	9,52(3/8")
SM812950	1/2	9,52(3/8")
SM814270	1/4	12,7(1/2")
SM813270	3/8	12,7(1/2")
SM812270	1/2	12,7(1/2")

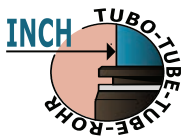
**[ 361 ]**

Cód.	Rosca	Tubo Ø
<b>[União Reta p/Painel c/Rosca FÊMEA NPT - Tubo INCH ]</b>		
SM81K310	1/8	3,18 (1/8")
SM81X310	1/4	3,18 (1/8")
SM81K390	1/8	3,97 (5/32")
SM81X390	1/4	3,97 (5/32")
SM81K470	1/8	4,76 (3/16")
SM81X470	1/4	4,76 (3/16")
SM81Y470	3/8	4,76 (3/16")
SM81K630	1/8	6,35(1/4")
SM81X630	1/4	6,35(1/4")
SM81Y630	3/8	6,35(1/4")
SM81U630	10-32UNF	6,35(1/4")
SM81K790	1/8	7,93(5/16")
SM81X790	1/4	7,93(5/16")
SM81Y790	3/8	7,93(5/16")
SM81Z790	1/2	7,93(5/16")
SM81K950	1/8	9,52(3/8")
SM81X950	1/4	9,52(3/8")
SM81Y950	3/8	9,52(3/8")
SM81Z950	1/2	9,52(3/8")
SM81X270	1/4	12,7(1/2")
SM81Y270	3/8	12,7(1/2")
SM81Z270	1/2	12,7(1/2")

**[ 366 ]**

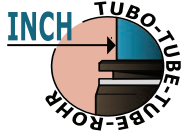
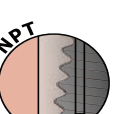
Cód.	Tubo Ø
<b>[Conexão Insertável ]</b>	
SM150030	3
SM150040	4
SM150050	5
SM150060	6
SM150080	8
SM150100	10
SM150120	12
SM150140	14
SM150160	16



**[ 367 ]**

Cód.	Tubo A Ø	Tubo B Ø
<b>[Conexão Insertável - Tubo INCH ]</b>		
SM150310	3,18 (1/8")	
SM150390	3,97 (5/32")	
SM150470	4,76 (3/16")	
SM150630	6,35(1/4")	
SM150790	7,93(5/16")	
SM150950	9,52(3/8")	
SM150270	12,7(1/2")	



**[ 368 ]**

Cód.	Tubo A Ø	Tubo B Ø
<b>[Pino com Espiga ]</b>		
SM724071	4	7
SM724081	4	8
SM726081	6	8
SM726101	6	10
SM728101	8	10
SM726121	6	12
SM728121	8	12
SM721121	10	12





**[ 369 ]**

Cód.	Tubo A Ø	Tubo B Ø
<b>[Pino com Espiga - Tubo INCH ]</b>		
SM723907	3,97 (5/32")	7
SM723908	3,97 (5/32")	8
SM726308	6,35(1/4")	8
SM726310	6,35(1/4")	10
SM727910	7,93(5/16")	10
SM726312	6,35(1/4")	12
SM727912	7,93(5/16")	12
SM729512	9,52(3/8")	12





**[ 362 ]**

Cód.	Rosca	Tubo Ø
<b>[Inserto Base + Rosca BSPT - Teflon ]</b>		
SM598040T	1/8	4
SM594040T	1/4	4
SM598050T	1/8	5
SM594050T	1/4	5
SM598060T	1/8	6
SM594060T	1/4	6
SM598080T	1/8	8
SM594080T	1/4	8
SM593080T	3/8	8
SM592080T	1/2	8
SM598100T	1/8	10
SM594100T	1/4	10
SM593100T	3/8	10
SM592100T	1/2	10
SM598120T	1/8	12
SM594120T	1/4	12
SM593120T	3/8	12
SM592120T	1/2	12
SM593140T	3/8	14
SM592140T	1/2	14
SM593160T	3/8	16
SM592160T	1/2	16

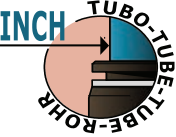

**[ 363 ]**

Cód.	Rosca	Tubo Ø
<b>[Inserto Base + Rosca BSPT - Teflon - Tubo INCH ]</b>		
SM598310T	1/8	3,18 (1/8")
SM594310T	1/4	3,18 (1/8")
SM598390T	1/8	3,97 (5/32")
SM594390T	1/4	3,97 (5/32")
SM598470T	1/8	4,76 (3/16")
SM594470T	1/4	4,76 (3/16")
SM593470T	3/8	4,76 (3/16")
SM598630T	1/8	6,35(1/4")
SM594630T	1/4	6,35(1/4")
SM593630T	3/8	6,35(1/4")
SM598790T	1/8	7,93(5/16")
SM594790T	1/4	7,93(5/16")
SM593790T	3/8	7,93(5/16")
SM592790T	1/2	7,93(5/16")
SM598950T	1/8	9,52(3/8")
SM594950T	1/4	9,52(3/8")
SM593950T	3/8	9,52(3/8")
SM592950T	1/2	9,52(3/8")
SM594270T	1/4	12,7(1/2")
SM593270T	3/8	12,7(1/2")
SM592270T	1/2	12,7(1/2")

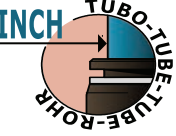

**[ 364 ]**

Cód.	Rosca	Tubo Ø
<b>[Inserto Base + Rosca NPT - Tubo INCH ]</b>		
SM59U310	10-32UNF	3,18 (1/8")
SM59K310	1/8	3,18 (1/8")
SM59X310	1/4	3,18 (1/8")
SM59U390	10-32UNF	3,97 (5/32")
SM59K390	1/8	3,97 (5/32")
SM59X390	1/4	3,97 (5/32")
SM59U470	10-32UNF	4,76 (3/16")
SM59K470	1/8	4,76 (3/16")
SM59X470	1/4	4,76 (3/16")
SM59Y470	3/8	4,76 (3/16")
SM59U630	10-32UNF	6,35(1/4")
SM59K630	1/8	6,35(1/4")
SM59X630	1/4	6,35(1/4")
SM59Y630	3/8	6,35(1/4")
SM59K790	1/8	7,93(5/16")
SM59X790	1/4	7,93(5/16")
SM59Y790	3/8	7,93(5/16")
SM59Z790	1/2	7,93(5/16")
SM59K950	1/8	9,52(3/8")
SM59X950	1/4	9,52(3/8")
SM59Y950	3/8	9,52(3/8")
SM59Z950	1/2	9,52(3/8")
SM59X270	1/4	12,7(1/2")
SM59Y270	3/8	12,7(1/2")
SM59Z270	1/2	12,7(1/2")

**[ 365 ]**

Cód.	Rosca	Tubo Ø
<b>[Inserto Base + Rosca Cilíndrica + O'ring ]</b>		
SM595048	M5	4
SM598048	1/8	4
SM594048	1/4	4
SM595058	M5	5
SM598058	1/8	5
SM594058	1/4	5
SM595068	M5	6
SM598068	1/8	6
SM594068	1/4	6
SM598088	1/8	8
SM594088	1/4	8
SM593088	3/8	8
SM592088	1/2	8
SM598108	1/8	10
SM594108	1/4	10
SM593108	3/8	10
SM592108	1/2	10
SM598128	1/8	12
SM594128	1/4	12
SM593128	3/8	12
SM592128	1/2	12
SM593148	3/8	14
SM592148	1/2	14
SM593168	3/8	16
SM592168	1/2	16



# REGULADORAS DE VELOCIDADE FLOW REGULATORS

**Sistema de ACOPLAMENTO DO TUBO**  
Type of TUBE COUPLING

**TUBO - Tube:**  
Ø4÷Ø14 - Ø5/32"÷Ø5/16"

**TIPOS DE TUBOS RECOMENDADOS**  
TYPE OF RECOMMENDED TUBES



**SM**

- POLIURETANO
- POLIAMIDA ( RILSAN PA11/12)
- POLIETILENO
- POLIESTER
- TEFLON
- NYLON ( PA6 )



**PARAFUSO DE AJUSTE**  
**TIPO MANÍPULO**  
ADJUSTING KNOB

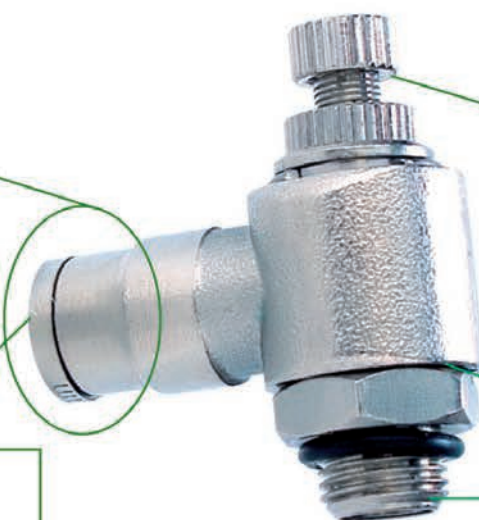

**ROSCA - Thread - Filet - Gewinde: M5 - 1/8"÷1/2"**  
cônica com Teflon, cilíndrica/métrica com o-ring, fêmea  
tapered with Teflon, parallel and metric with o-ring, female

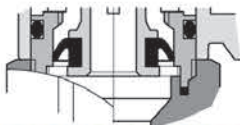
**REGULADOR POR CILINDRO**  
REGULATOR FOR CYLINDER

**REGULADOR POR VÁLVULA**  
REGULATOR FOR VALVE

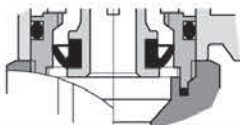
**REGULADOR BIDIRECIONAL**  
REGULATOR BIDIRECTIONAL

**O-RING/VEDAÇÕES** OIL-PROOF RUBBER  **SEM SILICONE** SILICONE FREE **O-RING ESPECIAIS A PEDIDO** SPECIAL O-RINGS ON REQUEST

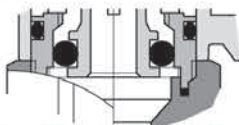
<p><b>DADOS TÉCNICOS</b> LATÃO (EN 12164-CW614N) NIQUELADO ZAMA-15 (UNI 3717) NIQUELADO VEDAÇÕES EM BORRACHA ANTI-ÓLEO NBR PRESSÃO MÁXIMA DE TRABALHO: 10 BAR (1 MPa) TEMPERATURA DE TRABALHO: -10°C (263°K), +80°C (353°K)</p>	<p><b>CARACTERÍSTICAS TÉCNICAS</b> LAITON (EN 12164-CW614N) NICKELÉ ZAMA-15 (UNI 3717) NICKELÉ JOINTS EN CAOUTCHOUC ANTI-HUILE NBR PRESSION MAXI D'EXERCICE: 10 BAR (1 MPa) TEMPERATURE DE TRAVAIL: -10°C (263°K), +80°C (353°K)</p>
---	--







**[2210] - [REGULAD. de VELOC. "SM"]**

	Cód.	Rosca	Tubo Ø
<b>[ 699 ]</b>  PARA CILINDRO BSPT x TEFLON	[Reguladora p/Cilindro c/Rosca BSPT - Teflon]		
	SM958040T	1/8	4
	SM954040T	1/4	4
	SM953040T	3/8	4
	SM958060T	1/8	6
	SM954060T	1/4	6
	SM953060T	3/8	6
	SM958080T	1/8	8
	SM954080T	1/4	8
	SM953080T	3/8	8
	SM952080T	1/2	8
	SM958100T	1/8	10
	SM954100T	1/4	10
	SM953100T	3/8	10
	SM952100T	1/2	10
	SM958120T	1/8	12
	SM954120T	1/4	12
	SM953120T	3/8	12
SM952120T	1/2	12	
SM953160T	3/8	16	
SM952160T	1/2	16	
<b>[ 700 ]</b>  INCH TUBO-TUBE PARA CILINDRO BSPT x TEFLON	[Reguladora p/Cilindro Rosca BSPT-Teflon-Tubo INCH]		
	SM958310T	1/8	3,18 (1/8")
	SM954310T	1/4	3,18 (1/8")
	SM958390T	1/8	3,97 (5/32")
	SM954390T	1/4	3,97 (5/32")
	SM958470T	1/8	4,76 (3/16")
	SM954470T	1/4	4,76 (3/16")
	SM953470T	3/8	4,76 (3/16")
	SM958630T	1/8	6,35 (1/4")
	SM954630T	1/4	6,35 (1/4")
	SM953630T	3/8	6,35 (1/4")
	SM958790T	1/8	7,93 (5/16")
	SM954790T	1/4	7,93 (5/16")
	SM953790T	3/8	7,93 (5/16")
	SM952790T	1/2	7,93 (5/16")
	SM958950T	1/8	9,52 (3/8")
	SM954950T	1/4	9,52 (3/8")
	SM953950T	3/8	9,52 (3/8")
SM952950T	1/2	9,52 (3/8")	
SM954270T	1/4	12,7 (1/2")	
SM953270T	3/8	12,7 (1/2")	
SM952270T	1/2	12,7 (1/2")	
<b>[ 701 ]</b>  INCH TUBO-TUBE PARA CILINDRO NPT	[Reguladora p/Cilindro c/Rosca NPT - Tubo INCH]		
	SM95U310	10-32UNF	3,18 (1/8")
	SM95K310	1/8	3,18 (1/8")
	SM95X310	1/4	3,18 (1/8")
	SM95U390	10-32UNF	3,97 (5/32")
	SM95K390	1/8	3,97 (5/32")
	SM95X390	1/4	3,97 (5/32")
	SM95U470	10-32UNF	4,76 (3/16")
	SM95K470	1/8	4,76 (3/16")
	SM95X470	1/4	4,76 (3/16")
	SM95Y470	3/8	4,76 (3/16")
	SM95U630	10-32UNF	6,35 (1/4")
	SM95K630	1/8	6,35 (1/4")
	SM95X630	1/4	6,35 (1/4")
	SM95Y630	3/8	6,35 (1/4")
	SM95K790	1/8	7,93 (5/16")
	SM95X790	1/4	7,93 (5/16")
	SM95Y790	3/8	7,93 (5/16")
SM95K950	1/8	9,52 (3/8")	
SM95X950	1/4	9,52 (3/8")	
SM95Y950	3/8	9,52 (3/8")	
SM95Z950	1/2	9,52 (3/8")	
SM95X270	1/4	12,7 (1/2")	
SM95Y270	3/8	12,7 (1/2")	
SM95Z270	1/2	12,7 (1/2")	
<b>[ 702 ]</b>  PARA CILINDRO BSP x O-RING	[Reguladora p/Cilindro c/Rosca BSP + Oring]		
	SM455048	M5	4
	SM456048	M6	4
	SM958048	1/8	4
	SM954048	1/4	4
	SM958058	1/8	5
	SM954058	1/4	5
	SM455068	M5	6
	SM456068	M6	6
	SM958068	1/8	6
	SM954068	1/4	6
	SM958088	1/8	8
	SM954088	1/4	8
	SM953088	3/8	8
	SM952088	1/2	8
	SM958108	1/8	10
	SM954108	1/4	10
	SM953108	3/8	10
SM952108	1/2	10	
SM958128	1/8	12	
SM954128	1/4	12	
SM953128	3/8	12	
SM952128	1/2	12	
SM953148	3/8	14	
SM952148	1/2	14	
SM953168	3/8	16	
SM952168	1/2	16	

	Cód.	Rosca	Tubo Ø
<b>[ 703 ]</b>  PARA CILINDRO BSPT x TEFLON	[Reguladora p/Cilindro Rosca BSPT-Teflon-Reg.c/Chave]		
	SM958040CT	1/8	4
	SM954040CT	1/4	4
	SM953040CT	3/8	4
	SM958060CT	1/8	6
	SM954060CT	1/4	6
	SM953060CT	3/8	6
	SM958080CT	1/8	8
	SM954080CT	1/4	8
	SM953080CT	3/8	8
	SM952080CT	1/2	8
	SM958100CT	1/8	10
	SM954100CT	1/4	10
	SM953100CT	3/8	10
	SM952100CT	1/2	10
	SM958120CT	1/8	12
	SM954120CT	1/4	12
	SM953120CT	3/8	12
SM952120CT	1/2	12	
SM953160CT	3/8	16	
SM952160CT	1/2	16	
<b>[ 704 ]</b>  INCH TUBO-TUBE PARA CILINDRO	[Reguladoras p/Cilindro c/Rosca BSPT-Teflon-Reg.c/chave - Tubo INCH]		
	SM958310CT	1/8	3,18 (1/8")
	SM954310CT	1/4	3,18 (1/8")
	SM958390CT	1/8	3,97 (5/32")
	SM954390CT	1/4	3,97 (5/32")
	SM958470CT	1/8	4,76 (3/16")
	SM954470CT	1/4	4,76 (3/16")
	SM953470CT	3/8	4,76 (3/16")
	SM958630CT	1/8	6,35 (1/4")
	SM954630CT	1/4	6,35 (1/4")
	SM953630CT	3/8	6,35 (1/4")
	SM958790CT	1/8	7,93 (5/16")
	SM954790CT	1/4	7,93 (5/16")
	SM953790CT	3/8	7,93 (5/16")
	SM952790CT	1/2	7,93 (5/16")
	SM958950CT	1/8	9,52 (3/8")
	SM954950CT	1/4	9,52 (3/8")
	SM953950CT	3/8	9,52 (3/8")
SM952950CT	1/2	9,52 (3/8")	
SM954270CT	1/4	12,7 (1/2")	
SM953270CT	3/8	12,7 (1/2")	
SM952270CT	1/2	12,7 (1/2")	
<b>[ 705 ]</b>  INCH TUBO-TUBE PARA CILINDRO NPT	[Reg. p/ Cilind.Rosca NPT-Reg.c/ chave - Tubo INCH]		
	SM95U310C	10-32UNF	3,18 (1/8")
	SM95K310C	1/8	3,18 (1/8")
	SM95X310C	1/4	3,18 (1/8")
	SM95U390C	10-32UNF	3,97 (5/32")
	SM95K390C	1/8	3,97 (5/32")
	SM95X390C	1/4	3,97 (5/32")
	SM95U470C	10-32UNF	4,76 (3/16")
	SM95K470C	1/8	4,76 (3/16")
	SM95X470C	1/4	4,76 (3/16")
	SM95Y470C	3/8	4,76 (3/16")
	SM95U630C	10-32UNF	6,35 (1/4")
	SM95K630C	1/8	6,35 (1/4")
	SM95X630C	1/4	6,35 (1/4")
	SM95Y630C	3/8	6,35 (1/4")
	SM95K790C	1/8	7,93 (5/16")
	SM95X790C	1/4	7,93 (5/16")
	SM95Y790C	3/8	7,93 (5/16")
SM95K950C	1/8	9,52 (3/8")	
SM95X950C	1/4	9,52 (3/8")	
SM95Y950C	3/8	9,52 (3/8")	
SM95Z950C	1/2	9,52 (3/8")	
SM95X270C	1/4	12,7 (1/2")	
SM95Y270C	3/8	12,7 (1/2")	
SM95Z270C	1/2	12,7 (1/2")	
<b>[ 706 ]</b>  PARA CILINDRO BSP x O-RING	[Reguladora p/Cilindro c/Rosca BSP+O'ring-Reg.c/chave]		
	SM455048C	M5	4
	SM456048C	M6	4
	SM958048C	1/8	4
	SM954048C	1/4	4
	SM958058C	1/8	5
	SM954058C	1/4	5
	SM455068C	M5	6
	SM456068C	M6	6
	SM958068C	1/8	6
	SM954068C	1/4	6
	SM958088C	1/8	8
	SM954088C	1/4	8
	SM953088C	3/8	8
	SM952088C	1/2	8
	SM958108C	1/8	10
	SM954108C	1/4	10
	SM953108C	3/8	10
SM952108C	1/2	10	
SM958128C	1/8	12	
SM954128C	1/4	12	
SM953128C	3/8	12	
SM952128C	1/2	12	
SM953148C	3/8	14	
SM952148C	1/2	14	
SM953168C	3/8	16	
SM952168C	1/2	16	





Linha **SM**

**VÁLVULAS**  
TAPS

**SISTEM**  
**DO BRASIL** Ltda.

## VÁLVULAS DE ESFERA BALL TAP



### Materiais de Construção

Latão niquelado (EN 12165-CW617N)  
Latão (EN 12164-CW614N)  
Vedação da esfera em PTFE  
Vedações em NBR  
Alavanca em nylon  
Parafuso em aço  
Pressão máxima de trabalho:  
10 Bar (1 MPa)  
Temperatura de trabalho:  
-10°C (263°K) +90°C (363°K)

### Material of Construction

NICKEL-PLATED BRASS  
Brass (EN 12164-CW614N)  
Seal of the sphere in PTFE  
Seal in NBR  
Lever in nylon  
Screw in steel  
Max Working Pressure:  
10 bar (1 MPa)  
Working temperature:  
-10°C (263°K) +90°C (363°K)

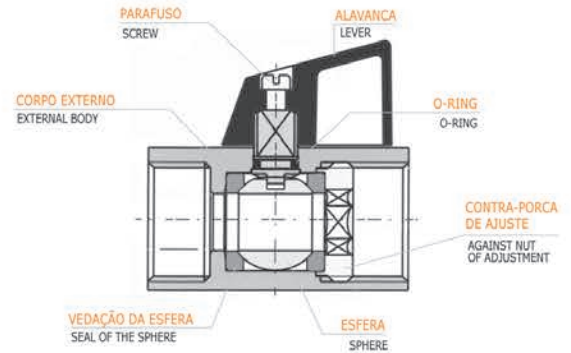

**Tipos de rosca**  
Thread types



Rosca cilíndrica / métrica  
Cylindrical thread / metric  
UNI-ISO 228/1-UNI 5542-65



Rosca cônica UNI-ISO 7/1  
Conical thread



Rosca cilíndrica fêmea  
Female cylindrical thread  
UNI-ISO 228/1

**O-RING/VEDAÇÕES**  
OIL-PROOF RUBBER



**SEM SILICONE**  
SILICONE FREE

**O-RING ESPECIAIS A PEDIDO**  
SPECIAL O-RINGS ON REQUEST

## [2440]-[VÁLV. de FECH. 2/3 Vias "SM"]

[ 707 ]



Cód.	Tubo Ø
[Válvula Fech.2/3 Vias Tubo/Tubo]	
SMRTT0040	4
SMRTT0060	6
SMRTT0080	8
SMRTT0100	10
SMRTT0120	12

[ 708 ]

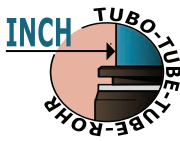

Cód.	Tubo	Tubo-INCH
[Válvula Fech.2/3Vias Tubo/Tubo-INCH]		
SMRTT0310	3,18 (1/8")	
SMRTT0390	3,97 (5/32")	
SMRTT0470	4,76 (3/16")	
SMRTT0630	6,35 (1/4")	
SMRTT0790	7,93(5/16")	
SMRTT0950	9,52(3/8")	
SMRTT0270	12,7(1/2")	

## [2450]-[VÁLV.deFECH.-ESFERA "SM"]

[ 710 ]

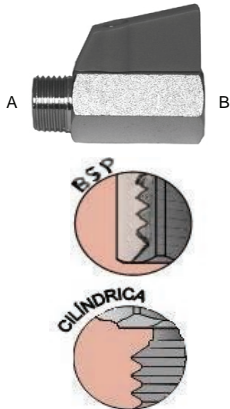

Cód.	Rosca A	Rosca B
["Mini" Válvula de Esfera Rosca Macho Cilínd.-Fêmea]		
SMMF08	1/8	1/8
SMMF04	1/4	1/4
SMMF03	3/8	3/8

[ 711 ]

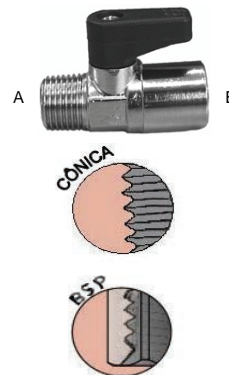

Cód.	Rosca A	Rosca B
[Válvula de Esfera Rosca Macho Cônica-Fêmea]		
SMSMF08	1/8	1/8
SMSMF04	1/4	1/4

[ 712 ]

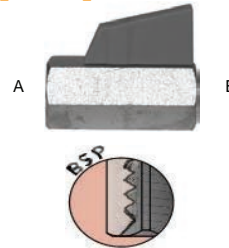

Cód.	Rosca A	Rosca B
["Mini" Válvula de Esfera Rosca Fêmea-Fêmea]		
SMFF08	1/8	1/8
SMFF04	1/4	1/4

[ 713 ]

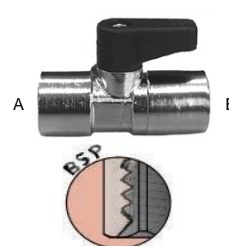

Cód.	Rosca A	Rosca B
[Válvula de Esfera Rosca Fêmea-Fêmea]		
SMSFF08	1/8	1/8
SMSFF04	1/4	1/4